



OWNER'S MANUAL

Instructions for the JUGS BP® 1 Combo Pitching Machine Model Number: M1501



SAVE THIS MANUAL

**ATTENTION, Coaches and Operators of
the JUGS BP®1 Combo Pitching Machine:**

This manual must be kept with the pitching machine at all times.

**Each coach and/or operator must read and understand
the instructions in this manual before using
the JUGS BP®1 Combo Pitching Machine.**

**Call 1-800-547-6843 or 503-692-1635
if you need additional copies.**

IMPORTANT

NOTE: For optimal use, JUGS Sports recommends the following extension cord gauges:

LENGTH OF CORD	CORD SIZE
Less than 50 feet	16 gauge (<i>or larger</i>)
50 to 200 feet	14 gauge (<i>or larger</i>)
Over 200 feet	12 gauge (<i>or larger</i>)

Table of Contents

Product Safety Signs and Labels	3
Rules for Safe Operation	5
Electrical	8
Terminology	10
Unpacking	13
Assembly	13
Operating Instructions:	
General Operating Instructions	17
Pitching Baseballs or Softballs to Batters	19
Fielding Practice for Baseball or Softball	23
Using JUGS for Lacrosse	24
Using JUGS for Field Hockey	25
Transporting	26
Maintenance	27
Product Specifications	28
Operator Notes	29
Warranty Information	31

Introduction

Your new JUGS pitching machine has been checked for quality and craftsmanship. Its innovative design is backed by four decades of research, development and manufacturing experience. It has many features designed to make your practices more efficient and enjoyable. Safety, performance and dependability have been given top priority in the design of all JUGS pitching machines, making them easy to operate and maintain. With proper care, your JUGS pitching machine will give you many years of enjoyable service.

At JUGS, we are committed to providing our customers with safe, dependable products. Your comments are always welcome and they help us to continue to be the #1 producer of ball-throwing machines in the world. Call or write to JUGS.

JUGS Sports

11885 SW Herman Rd.

Tualatin, OR 97062

Ph: 1-800-547-6843

Email: info@jugssports.com





Product Safety Signs & Labels

Safety Alert Symbols

Safety Alert Symbols indicate danger, warning or caution. These symbols may be used in conjunction with other symbols or pictographs. Failure to obey a safety warning will result in serious injury to yourself or to others. Always follow the safety precautions to reduce the risk of electric shock and personal injury.

 **DANGER:** Indicates an imminently hazardous situation which, if not avoided, will result in death or serious injury. This signal word is to be limited to the most extreme situations.

 **WARNING:** Indicates a potentially hazardous situation which, if not avoided, could result in death or serious injury.

 **CAUTION:** Indicates a potentially hazardous situation which, if not avoided, may result in minor or moderate injury. It may also be used to alert against unsafe practices.

Product Safety Signs and Labels

The purpose of product safety signs and labels is to attract your attention to possible dangers. The safety symbols, signal words and the explanations with them, deserve your careful attention and understanding. The safety warnings do not by themselves eliminate any danger. The instructions or warnings they give are not substitutes for proper accident prevention measures.

Safety Signs and Labels

Carefully read all safety sign decals affixed to machine before operating your JUGS pitching machine. See examples below.

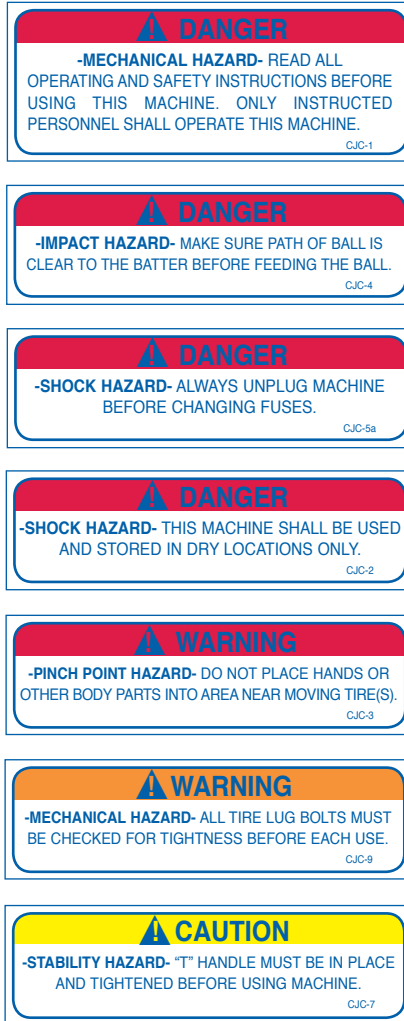

Figure 1

Rules For Safe Operation

- ⚠ WARNING:** JUGS pitching machines are intended for use by operators who are at least 18 years of age and who have been instructed in their use.
- ⚠ WARNING:** Do not attempt to operate this machine until you have read thoroughly and understand completely all instructions, safety rules, machine labels, etc. contained in this manual. Failure to comply can result in accidents involving electric shock or serious personal injury. Save this Owners Manual and review frequently for continuing safe operation, and for instructing others who may use this machine.
- ⚠ WARNING:** Do not connect your pitching machine to a power source until you have assembled and adjusted the machine as described in this manual and have read and understood all precautions and operating instructions in the manual and printed on the machine

READ THIS MANUAL:

- Know Your Pitching Machine. Read the Owner's Manual carefully. Learn the machine's capabilities, features and limitations as well as the specific potential hazards related to this machine.
- Guard against electrical shock by preventing body contact with grounded surfaces. For example: radiators, pipes, fences, or other enclosures.
- Keep the operator's area free of clutter. Pick up all loose balls around the machine and keep ball supply in a pail, bucket or other suitable container. Cluttered operating areas invite accidents.
- Do not allow children to operate the pitching machine. You must be at least 18 years of age or older and instructed in the proper operation, maintenance, care, and storage of this machine before operating it. Close supervision is necessary when this machine is used near children.

- Use the right ball. Use only JUGS Pearl[®], JUGS LeatherLast[®] Softballs, JUGS Sting-Free[®] dimpled style balls, Lite-Flite[®] balls, Softie[®] balls, Bulldog[™] poly balls, high-quality leather baseballs or softballs.
- Inspect extension cords periodically and replace if damaged.
- Use the proper extension cord. Make sure your extension cord is in good condition. When using an extension cord, be sure to use one heavy enough to carry the current your machine will draw. An undersized cord will cause a drop in line voltage resulting in loss of power and overheating. A wire gauge size (AWG) of at least 16 is recommended for an extension cord 25 feet or less in length. If in doubt, use the next heavier gauge. The smaller the gauge number, the heavier the cord.
- Do not abuse the cord. Never yank cord to disconnect it from receptacle. Keep cord away from heat, oil, and sharp edges. Stay constantly aware of cord location and keep it well away from the rotating tires.
- Dress properly. Do not wear loose clothing, gloves, neckties, rings, bracelets, or other jewelry. They can get caught and draw you into the moving parts. Long hair should be tied up and tucked under hats and helmets. Severe physical harm may result if loose clothing, jewelry or hair is caught in rotating tires.
- Always wear safety glasses and batting helmets while the wheels are rotating. Debris on the tires can fly off and cause physical harm. Everyday eyeglasses have only impact-resistant lenses; they are NOT safety glasses.
- Never touch rotating tires. Do not put hands or fingers into ball feed chute. Hands and fingers should only go to the edge of the chute (or the edge of the sleeve in the case of fly ball or pop-up practice).
- Inspect machine before every use. If damaged, have repaired by a qualified JUGS service technician.
- Inspect tires before every use. Be sure tires are free of grit and debris before turning on machine.
- Do not use machine if ON/OFF switch does not work. In the unlikely event that the switch becomes defective, have it replaced by a qualified JUGS service technician.
- Keep machine clean, and free of grit and dirt. With the machine

unplugged, use only a clean damp cloth for cleaning. Never use brake fluids, gasoline, petroleum-based products, or any solvents to clean machine.

- Tighten lock knobs and T-clamps securely after adjusting trajectory.
- To protect the operator, a pitcher's screen must be placed in front of the pitching machine.
- Only operate and store this pitching machine in a clean, dry location. Do not use outdoors if it is raining. If machine becomes wet, do not use. A potential shock hazard exists if this machine is used while or after it has been exposed to water. Hand dry surface water from machine with a clean cloth and allow the machine to completely air dry before its next use.
- Avoid awkward operations and hand positions where a sudden slip could cause your hand to move into the rotating tires. ALWAYS make sure you have good footing and balance.
- Replacement parts. All repairs, whether electrical or mechanical, should be made by a qualified JUGS service technician. When servicing, use only JUGS replacement parts.
- Do not operate this machine under the influence of drugs, alcohol, or any medication.
- Stay alert and exercise control. Watch what you are doing and use common sense. Do not operate this machine when you are tired. Do not rush.
- Avoid accidental starting when reconnecting to a power supply. Always turn off machine before disconnecting it from power source. Never leave machine running unattended. Turn the power off. Do not leave machine until tires come to a complete stop.

⚠ WARNING: Do not allow your familiarity with the machine to cause you to be careless. Remember that a careless fraction of a second is enough time to inflict severe injury to yourself or others.

SAVE THIS MANUAL. Refer to it often and use it to instruct other users. Do not loan your pitching machine to anyone who has not been instructed in its use. If you do loan your machine, be sure this manual goes with it.

Electrical

Grounding Instructions

This product must be grounded. If it should malfunction or break down, grounding provides a path of least resistance for electric current to reduce the risk of electric shock. This product is equipped with a cord having an equipment-grounding conductor and grounding plug. The plug must be connected to an appropriate GFCI outlet that is properly installed and grounded in accordance with all local codes and ordinances.

Do not modify the plug provided. If it will not fit the outlet, have the proper outlet installed by a qualified electrician. Improper connection of the equipment-grounding conductor can result in a risk of electric shock. The conductor with insulation having an outer surface that is green with or without yellow stripes is the equipment grounding conductor. If repair or replacement of the electric cord or plug is necessary, do not connect the equipment-grounding conductor to a live terminal.

Check with a qualified electrician or service personnel if the grounding instructions are not completely understood, or if in doubt as to whether the pitching machine is properly grounded.

Extension Cords

Use only 3-wire 16 AWG or larger grounding type extension cords that have 3-prong grounding plugs and 3-pole receptacles that accept the machine's plug. When using the machine at a considerable distance from a power source, use an extension cord heavy enough to carry the current that the machine will draw (**See recommended cord gauge notice inside front cover.**) An undersized extension cord will cause a drop in line voltage, resulting in a loss of power and causing the motor to overheat. Only round jacketed cords listed by Underwriter's Laboratories (UL) should be used.

When working with the machine outdoors, use an extension cord designed for outside use. This is indicated by the letters “WA” on the cord’s jacket. Before using the extension cord, inspect it for loose or exposed wires and cut or worn insulation.

⚠ WARNING: Keep the cord away from the rotating tire area. Repair or replace a damaged or worn cord immediately.

Electrical Connection

Your JUGS pitching machine is powered by a 90 volt motor. Do not operate this machine on direct current (DC). A substantial voltage drop will cause a loss of power and the motor will overheat. If the machine does not operate when plugged into an outlet, double check the power supply. Your pitching machine will operate under a standard 110 voltage AC outlet. Do not use an adapter with this product.

This machine is intended for use on a circuit that has an outlet like the one shown in Figure 2. It also has a grounding pin like the one shown.

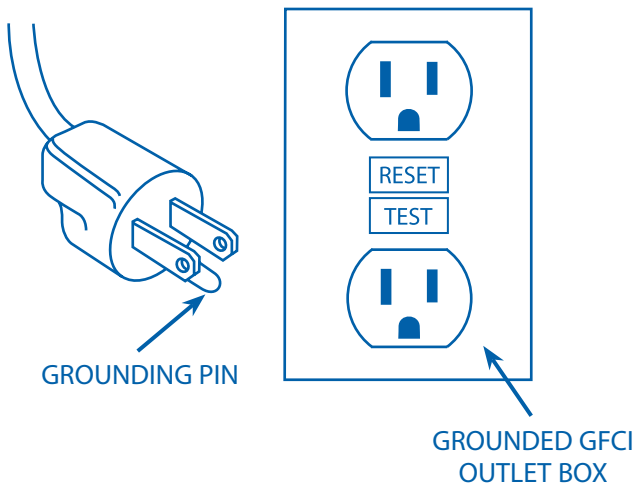

Figure 2

Terminology

Straight Leg Assembly for baseball

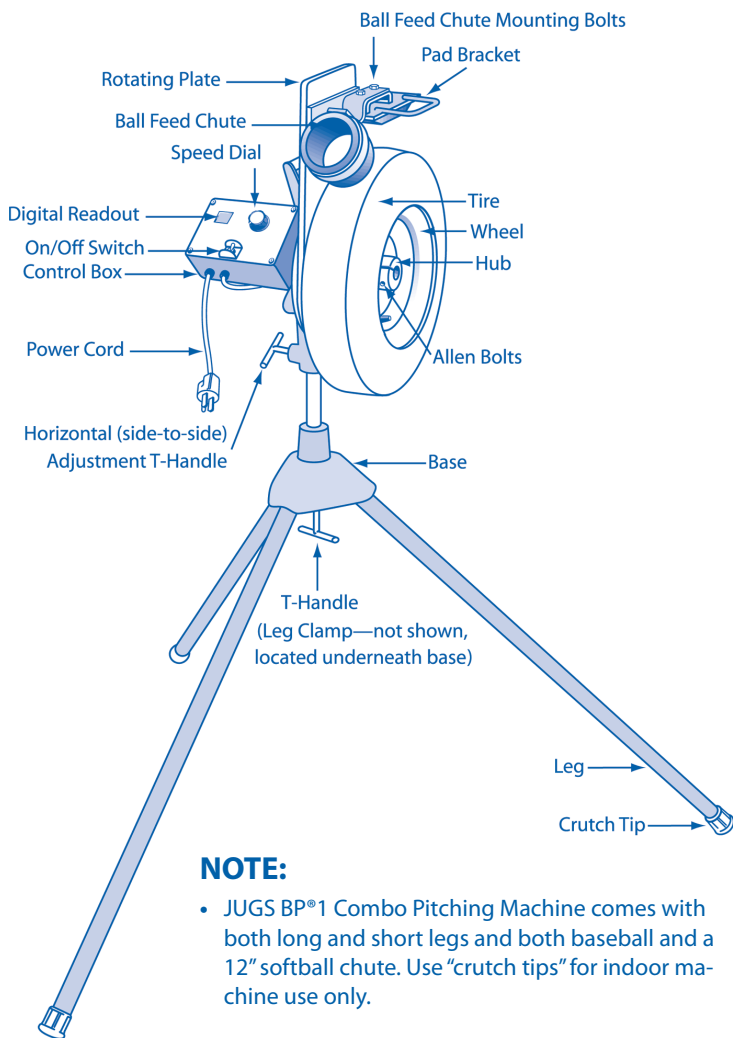

Figure 3

Terminology

Curved Leg Assembly for softball

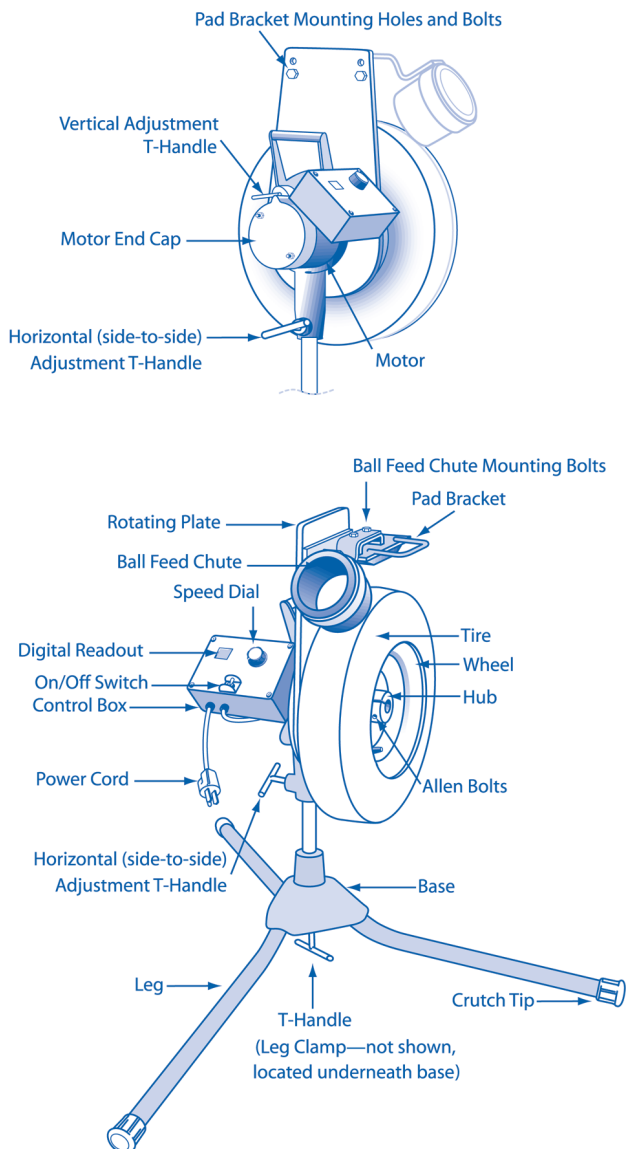

Figure 4

Terminology



Top of Machine

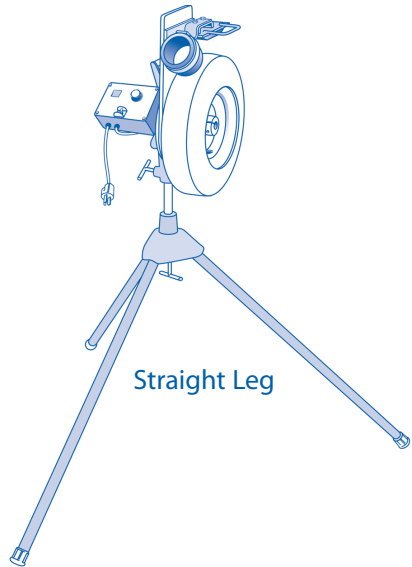
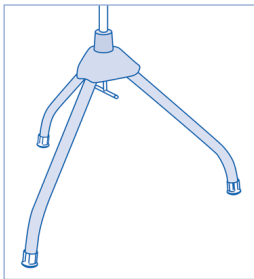
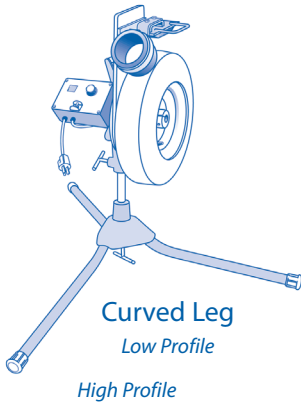

Figure 5

Unpacking

⚠ WARNING: To prevent accidental starting or electrical shock that could cause possible serious injury, assemble all parts to your machine before connecting it to the power supply. The pitching machine should never be connected to a power supply when you are assembling parts, making adjustments, cleaning, servicing, or when not in use.

- Carefully lift machine from carton and place on level surface.
- Make sure you have all the parts (See Figures 3 and 4). If any parts are missing, do not operate the machine until the missing parts are replaced. Failure to do so could result in possible serious personal injury.
- Do not discard the packing materials until you have carefully inspected the machine, identified all the parts, and satisfactorily operated the machine.

NOTE: If any parts are damaged or missing, do not attempt to plug in the power cord and turn on switch until the damaged or missing parts are obtained and are installed correctly.

Assembly

JUGS is shipped with the base secured tightly to the “top” of the machine.

1. Separate the “top” from the base casting.

- a. Loosen the Horizontal T-Handle.
- b. Grasp the lifting handle and pull the “top” off the base.
This can be done very simply with one person holding the “top” and a second person holding the base casting.

Assembly

Your JUGS BP®1 pitching machine comes with two sets of legs depending on how you will use it. Use the straight legs for baseball or lacrosse. Use the curved set of legs for softball or field hockey. Please read carefully.

2. Installing the legs:

- Screw the base T-Handle clockwise into the bottom of the base casting, until the T-Handle engages the threads (see Figure 6).
- Slide the three legs into place. Be sure the end of each leg is completely inserted and in contact with the back of the casting slot.
- Hand tighten the base T-Handle and set the “bottom” of the machine on its legs.
- If the legs appear wobbly:
 - Make sure the legs are snug and properly placed in the base.
 - Make sure the base T-Handle is turned as tightly, by hand, as possible.
 - Be sure the legs are equidistant from one other (Figure 7).

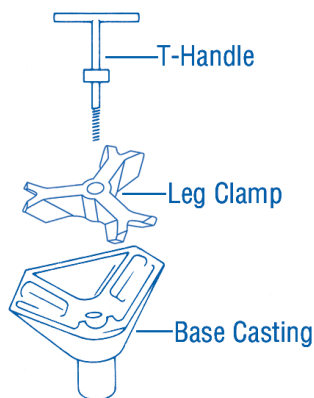

Figure 6

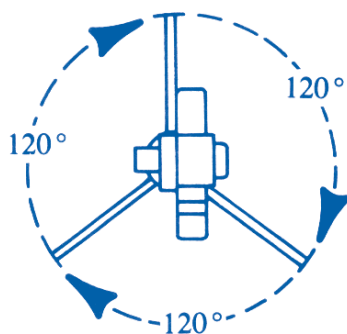

Figure 7

Assembly

There are two ways to install the curved legs; the low profile position or the high profile position.

Low Profile Position:

Install the three legs with the curved part closer to the base (see Figure 8). Use this position for softball or field hockey.

High Profile Position:

Install the three legs with the curved part closer to the ground (see Figure 9). Use this position for softball drop pitches.

NOTE: When using JUGS indoors, be sure the white rubber leg caps are on the legs.

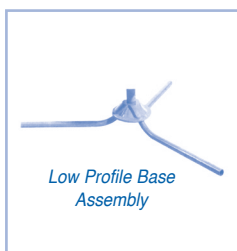

Figure 8

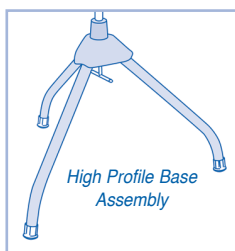

Figure 9

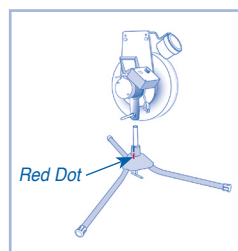

Figure 10

3. Re-connecting the “Top” of JUGS onto the Base Assembly:

- Loosen the Horizontal T-Handle.
- Place the “top” of JUGS onto the shaft of the base assembly. (see Figure 10).
- Turn the “top” of JUGS so the Horizontal T-Handle is lined up directly OVER the red dot at the base.
- Hand tighten the Horizontal T-Handle.

IMPORTANT: The Horizontal T-Handle will fit snugly into the indentation in the shaft only if you have the horizontal T-Handle lined up directly over the RED DOT. This is important for maximum accuracy.

Assembly

4. Attach the feed chute.

- Remove the bolts holding the rubber pad bracket to the rotating plate (½-inch wrench).
- Select the correct feed chute for your intended use. Your JUGS comes with two feed chutes: the larger one is for softball, the smaller is for baseball, lacrosse and field hockey (see Figure 11).
- Attach the selected feed chute to the rubber pad bracket by using the two bolts provided (½-inch wrench).

5. Attach the rubber pad bracket to the rotating plate.

The rotating plate has 2 sets of bolt holes (see Figure 11). Use the bolts provided to attach the rubber pad bracket to the rotating plate described below (½-inch wrench).

- The upper set of bolt holes is for positioning the rubber pad bracket (and attached feed chute) for both 11 and 12-inch softball use;
- The lower set of bolt holes is used for baseball, field hockey and lacrosse

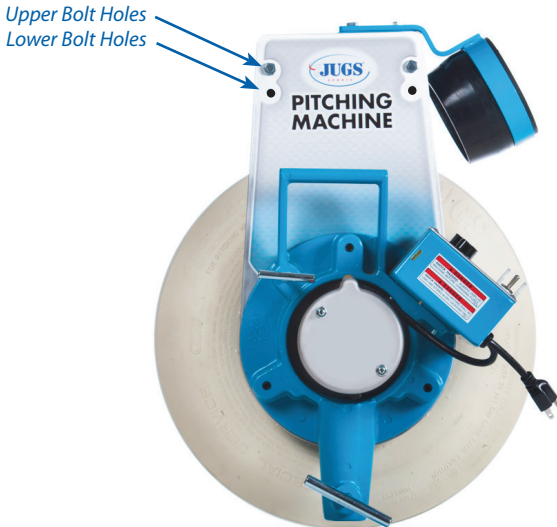
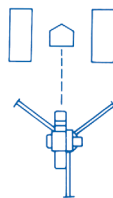

Figure 11

Operation

General Operating Instructions

IMPORTANT: Always position the pitching machine so that two legs are facing the pitching screen and batter, and one leg is facing back, towards the operator, except as noted in Figure 14, page 23.



1. Be sure the control switch is in the "OFF" position.
2. Position the speed dial pointer on the control panel at MINIMUM (see Figure 12).

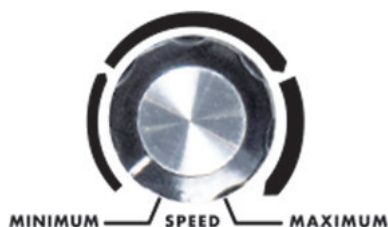

Figure 12

3. Select the correct set of legs for your use (refer to page 14):
 - a. Use the straight legs for baseball and lacrosse use.
 - b. Use the curved set of legs (low profile) for softball or field hockey.
4. Select the correct feed chute for your use (see Figure 12a).



Figure 12a

5. Position the rubber pad bracket until the bolt holes line up with the upper bolt holes in the rotating plate for softball use, or the lower bolt holes for baseball, field hockey or lacrosse use (see Figure 11).

Operation

6. Connect a 3-wire extension cord (3-prong) into a grounded (3-prong) 110 volt AC outlet (see Figure 2).
7. Move control switch to "ON" position.

⚠ CAUTION: Never loosen the vertical T-Handle without holding the chute handle.

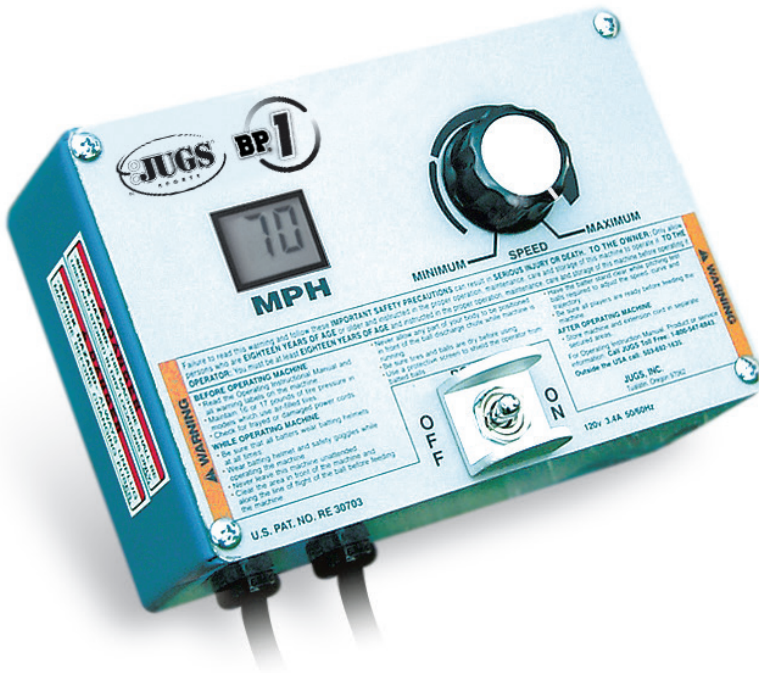

Figure 13. Control Panel

Operation

Pitching to Batters

Follow all safety performance instructions in this manual. The following feeding instructions should be used to insure accurate and efficient operation of the JUGS Pitching Machine.

IMPORTANT PITCHING MACHINE FEEDING INSTRUCTIONS:

1. When feeding the machine with leather balls, hold the ball the same way every time. Across the seams is best.
2. Have all batters and observers stand well clear of the target as you throw test balls to adjust trajectory and aiming point.
3. **VERY IMPORTANT:** Before you place the ball in the feeding chute, you should look up at the batter and make absolutely sure the batter is watching you and is ready to receive the pitch. It is extremely important that you make sure that the immediate area in front of the pitching machine and the flight path of the ball is clear before you feed the balls into the pitching machine.
4. When the batter has taken his/her stance and indicates he or she is ready to hit, hold the ball high in the air where the batter can see the ball. Then bring the ball down to the chute simulating live action so that the batter can time the ball correctly. Set the ball in the feed chute and release. Do not drop the ball into the chute. Watch the ball into the wheels, then look up at the batter. The whole feeding operation should be smooth and without interruption.
5. Every batter, after taking his/her stance, as well as between pitches, goes through a personal readiness routine. The ball feeder should adjust the pitch spacing to each batters' habits accordingly. This will assure that the batter is ready to receive the pitch and will also help to simulate live action. The batter can then regard each throw as a separate pitch and avoid becoming an "automatic swinger". Generally speaking, pitches can be spaced between 6 and 10 seconds apart.
6. Out-of-round, soft, mushy, or wet balls will affect accuracy of pitches and must not be used. Mixing different types of balls (leather, rubber, JUGS, etc.) will affect consistency of pitches. For best accuracy, throw only one type of ball at a time.

Operation

7. Use the right ball. Use only JUGS Pearl®, JUGS LeatherLast® Softballs, JUGS Sting-Free® dimpled style balls, Lite-Flite® balls, Softie® balls, Bulldog™ poly balls, high-quality leather baseballs or softballs.
8. Do not permit more than one or two persons around the pitching machine during its operation.

BATTERS—BATTING HELMETS MUST BE WORN AT ALL TIMES.

9. Operators of JUGS Pitching Machines must wear safety glasses and batting helmets at all times.
10. At the beginning of practice, or after any change in speed, or trajectory, have the batter stand well clear while at least one test ball is thrown to make sure the ball is thrown at the desired target. If you move the machine for any reason, repeat this process.
11. Throw balls at speeds the batter can learn to hit. As the batter's skills increase you can throw faster pitches. Always pitch balls at a speed suitable for the age and skill level of the batter. Pitches thrown too fast will be counterproductive and dangerous.

NOTE: We suggest that each operator spend a couple of hours experimenting with the JUGS BP®1. pitching machine. (You may want to jot down the wheel position and speed dial settings in the space provided on pages 29-30 for future reference). Try many different speed settings. Do not be afraid that any setting you make will harm the pitching machine; however, you should use a wide backstop when experimenting with faster speeds.

⚠ WARNING: A pitching screen must be used to protect the operator and the machine from batted balls.

12. Place ball into feed chute and watch the trajectory of the ball.
13. Increase the speed of the pitch by turning the dial clockwise (see Figure 13).
 - When you increase speed of any pitch, you must lower the elevation of aim; when you decrease the speed, you must increase the aim elevation.

Operation

14. To regulate the height of the pitch:

- Hold the feed chute handle and loosen the Vertical T-Handle.
- Move the feed chute TOWARDS home plate for a lower pitch
Move the feed chute AWAY from home plate for a higher pitch.
- Hand tighten the Vertical T-Handle.

⚠ WARNING: Never loosen the Vertical T-Handle without holding the chute handle.

15. To regulate the direction of the pitch:

- Loosen the Horizontal T-Handle.
- Grasp the chute handle and move the “top” of the JUGS sideways until the chute is aimed at the desired target.
- Hand tighten Horizontal T-Handle.

NOTE: When throwing faster pitches (dial setting 45-70 mph), be sure to line up Horizontal T-Handle over the red dot on the base and then tighten the Horizontal T-Handle. To make small lateral adjustments (for example, from “outside corner” pitches to “inside corner” pitches) simply “shift” the legs of the pitching machine slightly by gently tapping the legs with your foot.

Operation

Proper Position of the Feed Chute for Various Throws:

- **Straight Balls and Risers**

Position the feed chute level to throw straight balls and risers by adjusting the Vertical T-Handle. To make the ball “rise”, turn the control dial up to 45 mph or more. Under 45 mph, the ball will move straight.

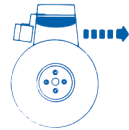

- **Slow Pitch Tosses**

By adjusting the Vertical T-Handle, position the feed chute slightly upward for soft pitch tosses (or higher for fly balls, see Fielding Practice). The dial setting should be around 25 mph for slow pitch tosses.



- **Drop Balls**

The legs should be in the “High Profile” position. Position the two legs so they point in the direction of second base, and one leg points toward home plate. (This is the exact opposite of the position of the legs when you are throwing straight balls. See Figure 15).

One JUGS leg should be pointing at home plate when throwing drop balls. When throwing risers, one JUGS leg should be pointing at second base.

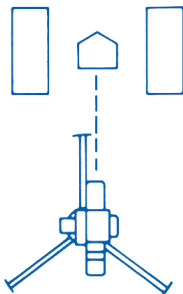

Drop Balls

Figure 15

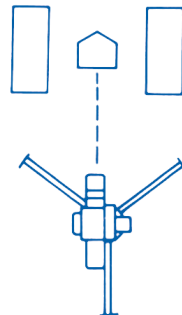

Straight Balls

Operation

Fielding Practice for Baseball or Softball

1. **VERY IMPORTANT:** Before you place the ball in the feed chute, you should look up at the fielder and make absolutely sure the fielder is watching you and is ready to receive the ball. It is extremely important that you make sure that the immediate area in front of the pitching machine and the flight path of the ball is clear before you feed the balls into the pitching machine.
2. When the fielder has taken his/her stance and indicates he or she is ready, hold the ball high in the air where the fielder can see the ball. Then bring the ball down to the chute simulating live action so that the fielder can time the ball correctly. Set the ball in the feed chute and release. Do not drop the ball into the chute. Watch the ball into the wheels, then look up at the fielder. The whole feeding operation should be smooth and without interruption.
3. Every fielder, after taking his/her stance, as well as between pitches, goes through a personal readiness routine. The ball feeder should adjust the throw spacing to each fielder's habits accordingly. This will assure that the fielder is ready to receive the ball and will also help to simulate live action.
 - **Fly Balls:** (curved legs must be in "Low Profile" or straight leg position when throwing fly balls) and the feed chute should be pointed upward.
 - **Ground Balls:** (legs must be in "High Profile" or straight leg position when throwing grounders and the feed chute should be pointed downward.
 - **Pop-ups to Catchers:** By adjusting the Vertical T-Handle, position the feed chute to point upward vertically for pop-ups to catchers. The ball will go straight up.

 **WARNING:** When throwing pop-ups, the operator must wear a catchers mask.

Operation

Using JUGS BP®1 for Lacrosse:

1. Follow the assembly instructions for the “High Profile” setup as shown in Figure 9 on page 15, or use long straight legs.
2. Install the small diameter feed chute (baseball chute) for lacrosse (see Figure 11), and position the rubber pad bracket until the bolt holes line up with the lower set of bolt holes in the rotating plate (see Figure 12).
3. Follow the general operating instructions as described in steps 1- 6 on page 17.

The following diagrams depict the proper position of the feed chute for various shots or passes:

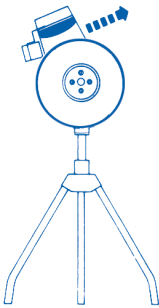

High “lob” Tosses

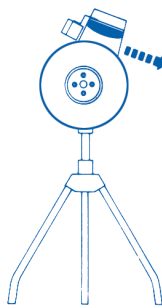

Bouncing Passes

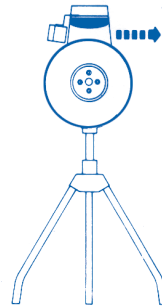

“Straight-Line” Throws

Operation

Using JUGS BP®1 for Field Hockey:

1. Follow the assembly instructions for the “Low Profile” setup as shown in Figure 8 on Page 15.
2. Install the small diameter feed chute (baseball chute) for field hockey (see Figure 11), and position the rubber pad bracket until the bolt holes line up with the lower set of bolt holes in the rotating plate (see Figure 12).
3. Follow the general operating instructions as described in steps 1- 6 on page 17, then add the following below:
 - a. Loosen the Vertical T-Handle and lower the rotating plate down until the feed chute is at the bottom as shown in the diagrams below. Hand-tighten T-Handle.
 - b. Position machine so it will throw a “ground hugging” pass to one of your players about 20 yards away.
 - c.. Move control switch to the “ON” position.
 - d. Place ball into feed chute and watch the trajectory of the ball.
 - e. Increase the speed of the ball by turning the dial clockwise (refer to Figures 12 and 13).
 - f. To regulate the trajectory of each ball thrown:
 - Hold the chute handle and loosen the Vertical T-Handle.
 - Move the chute handle AWAY from you for a “lobbing flick” pass. Move the chute directly UNDER the tire for a “ground hugging” pass.

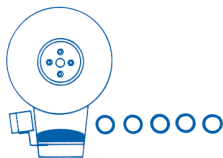

“Ground hugging” Passes



Lobbing “flick” Passes

Transporting

1. Using the Vertical T-Handle, lock the rotating plate in “pop fly to catchers” position (vertically upward).
2. Make sure the Horizontal T-Handle engages the indentation of the base shaft. This is done by lining up the Horizontal T-Handle with the red dot on the base casting, and hand-tightening the T-Handle.
3. Lower JUGS to a horizontal position, with the feed chute facing upward.
4. Slightly loosen the base T-Handle that secures the legs.
5. Grasp two legs, and twist them towards your sides.
6. Tighten the base T-Handle.
7. Grasp and lift the two legs. Roll JUGS BP®1 as you would a wheelbarrow.



Maintenance

Review the following instructions carefully to maintain maximum accuracy with your JUGS Pitching Machine.

- Maintain tire pressure at 16 to 17 psi (25 psi for tennis balls).

Cleaning

- Keep machine clean, and free of grit and dirt. Always use a clean damp cloth when cleaning. Never use brake fluids, gasoline, petroleum-based products, or any solvents to clean machine.
- Periodically, you must clean the tires to help maintain their maximum performance. A dirty tire can easily be distinguished by either a dark ring around the tire surface or when the surface itself has turned yellow and has a very glossy or shiny finish.
- Take medium grade sandpaper (sometimes an even coarser grade is necessary depending on the amount of soil buildup) and begin to scrub the tire surface as you would a very dirty frying pan. This process can be very tedious and could take up to 10 minutes per tire. However, it is necessary in order to completely clean the rubber of all foreign substances, as well as prepare it for better machine performance. You should sand the tires whenever you notice the soil build-up forming. Always sand tires with the power switch OFF and the machine unplugged.

Once you complete this operation the tire surface will, in most cases, take on the white color it was originally. Maintaining the tire in this fashion will not only maximize the performance and accuracy of your machine, but it will extend the life of the tire.

Storage

- Always store machine and extension cord in separate, clean, dry secured areas. Cover the machine with a suitable dust cover that does not retain moisture. Do not use plastic.

Product Specifications

JUGS BP®1 Combo Product Specifications:

Motor Specifications:

Variable Speed

Speed Range	15–70 mph
Maximum developed horse power	¼ hp
Volts	90v DC
Amps	3 amps
Hertz	50/60 Hz
RPM (no load)	1900 rpm
Overload protection	yes

Tire Specifications:

Size	4.00/4.80-8
Pressure	16-17 lbs.

Frame Specifications:

Legs	steel tubing
Motor Mount and Leg Clamp Casting	cast aluminum
Ball Feed Chute	cast aluminum

Set up for Baseball:

Height	59 in.
Width	56 in.
Weight	75 lbs.

Set up for Softball:

Height	38 in.
Width	42 in.
Weight	75 lbs.

Recommended Generator	Yamaha® Generator 2000
Recommended Balls	JUGS Balls, high quality leather baseballs or softballs

IMPORTANT: Servicing requires extreme care and knowledge of the machine and should be performed only by JUGS. For service, we suggest you return the machine to JUGS for repair. Always use original factory replacement parts when servicing.

Warranty

JUGS Sports guarantees that the JUGS Pitching Machines are well made; of good materials, and workmanship; and agrees that if, within two years after shipment thereof, any part so guaranteed should fail because of defective material or workmanship in its manufacture, the Company will repair or replace such part, free of charge F.O.B. to its factory in Tualatin, Oregon; provided, however, that upon request, the Buyer shall return the allegedly defective part to the Company's factory with transportation charges thereon prepaid. Commercial use of any JUGS product automatically limits this warranty to 30 days after date of shipment.

This warranty shall not be effective if the equipment has been subject to misuse, negligence or accident, nor if the equipment has been repaired or altered outside of our Tualatin factory in any respect which, in our judgment, affects its condition or operation.



CUT AND RETURN CARD BELOW TO JUGS SPORTS



Warranty Record

JUGS Serial No. _____ Date Delivered: _____

Model: **JUGS BP®1 M1501** _____

Name: _____

Address: _____

_____ Zip: _____

Phone: () _____

Purchased From: _____

Type of Activity (Youth League, High School, College, etc.): _____

Coach/Manager Name: _____



In the USA and Canada, call toll-free: 1-800-547-6843
Internationally, call collect: 0-503-692-1635
Fax us: 503-691-1100
Visit our website: jugssports.com

JUGS BP[®]1 M1501

Model

Serial No.

Date Delivered

↑ SAVE THIS PORTION FOR YOUR RECORDS ↑

PLACE
STAMP
HERE

JUGS Sports
P.O. Box 365
Tualatin, Oregon 97062

If you need more information about
this product or any other JUGS product or service,
please contact the manufacturer:



In the USA and Canada,
call toll-free: 1-800-547-6843.

For International Orders,
call collect: 0-503-692-1635.

Our fax number is
1-503-691-1100.

Visit our website at
jugssports.com.

Se habla español.