



OWNER'S MANUAL

Operating Instructions for the JUGS® BP®2 Cricket Bowling Machine



SAVE THIS MANUAL

ATTENTION: Coaches and operators of this cricket machine.

**This manual must be kept with the cricket machine at all times.
Each coach and/or operator must read and understand this manual
before using the JUGS BP®2 Cricket Bowling Machine.**

Call 1-800-547-6843 or 503-692-1635 for additional copies
of this manual if necessary.

Table of Contents

Introduction	2
Product Safety Signs and Labels	3
Rules for Safe Operation.	5–7
Electrical.	8–9
Terminology	10
Unpacking	11
Set Up	11–12
Transporting	12
Operation	14–23
Bowling to Batters.	15–16
Bowling Different Deliveries	18
• Fast/Medium Pace	19
• Leg Break/Advanced InSwing.	20
• InSwing/OutSwing.	21
• Off Break/Advanced OutSwing	22
BP®2 Product Specifications	24
Maintenance	25
Operator Notes	26
Warranty Information	27

Introduction

Your new JUGS BP®2 Cricket Bowling Machine has been checked for quality and craftsmanship. Its innovative design is backed by four decades of research, development and manufacturing experience. It has many features designed to make your practices more efficient and enjoyable. Safety, performance and dependability have been given top priority in the design of all JUGS machines, making them easy to operate and maintain. With proper care, your JUGS cricket machine will give you many years of enjoyable service.





At JUGS Sports, we are committed to providing our customers with safe, dependable products. Your comments are always welcome and they help us to continue to be the #1 producer of ball-throwing machines in the world. Please call 1-800-547-6843, email to info@jugssports.com, or write to JUGS with your comments.

Product Safety Signs & Labels

Safety Alert Symbols

Safety Alert Symbols indicate danger, warning or caution. These symbols may be used in conjunction with other symbols or pictographs. Failure to obey a safety warning will result in serious injury to yourself or to others. Always follow the safety precautions to reduce the risk of electric shock and personal injury.

 **DANGER:** Indicates an imminently hazardous situation which, if not avoided, will result in death or serious injury. This signal word is to be limited to the most extreme situations.

 **WARNING:** Indicates a potentially hazardous situation which, if not avoided, could result in death or serious injury.

 **CAUTION:** Indicates a potentially hazardous situation which, if not avoided, may result in minor or moderate injury. It may also be used to alert against unsafe practices.

Product Safety Signs and Labels:

The purpose of product safety signs and labels is to attract your attention to possible dangers. The safety symbols, signal words and the explanations with them, deserve your careful attention and understanding. The safety warnings do not by themselves eliminate any danger. The instructions or warnings they give are not substitutes for proper accident prevention measures.

Safety Signs and Labels

Carefully read all safety sign decals affixed to machine before operating your JUGS cricket machine. See examples below.

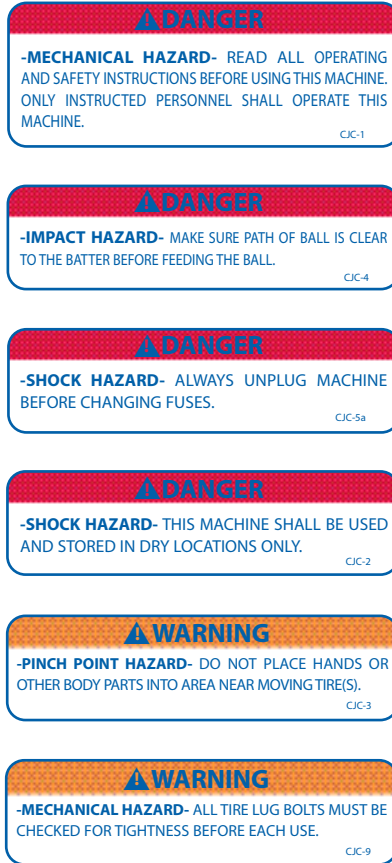

Figure 1

Rules For Safe Operation

⚠ WARNING: JUGS cricket machines are intended for use by operators who are at least 18 years of age and who have been instructed in their use.

⚠ WARNING: Do not attempt to operate this machine until you have read thoroughly and understand completely all instructions, safety rules, machine labels, etc., contained in this manual. Failure to comply can result in accidents involving electric shock or serious personal injury. Save this Owners Manual and review frequently for continuing safe operation, and for instructing others who may use this machine.

⚠ WARNING: Do not connect your cricket machine to a power source until you have assembled and adjusted the machine as described in this manual and have read and understood all precautions and operating instructions in the manual and printed on the machine.

Read this Manual

- **Know Your Cricket Machine.** Read the Owner's Manual carefully. Learn the machine's capabilities, features and limitations as well as the specific potential hazards related to this machine.
- **Guard against electrical shock by preventing body contact with grounded surfaces.** For example: radiators, pipes, fences, or other enclosures.
- **Keep the operator's area free of clutter.** Pick up all loose balls around the machine and keep ball supply in a pail, bucket or other suitable container. Cluttered operating areas invite accidents.
- **Do not allow children to operate the cricket machine.** You must be at least 18 years of age or older and instructed in the proper operation, maintenance, care, and storage of this machine before operating it. Close supervision is necessary when this machine is used near children.
- **Use the right ball.** Use only JUGS Dimpled-Style Cricket balls, or regulation size cricket balls in this machine

Rules For Safe Operation

- **Inspect extension cords** periodically and replace if damaged.
- **Use the proper extension cord.** Make sure your extension cord is in good condition. When using an extension cord, be sure to use one heavy enough to carry the current your machine will draw. An undersized cord will cause a drop in line voltage resulting in loss of power and overheating. A wire gauge size (AWG) of at least 16 is recommended for an extension cord 25 feet or less in length. If in doubt, use the next heavier gauge. The smaller the gauge number, the heavier the cord.
- **Do not abuse the cord.** Never yank cord to disconnect it from receptacle. Keep cord away from heat, oil, and sharp edges. Stay constantly aware of cord location and keep it well away from the rotating tires.
- **Dress properly.** Do not wear loose clothing, gloves, neckties, rings, bracelets, or other jewelry. They can get caught and draw you into the moving parts. Long hair should be tied up and tucked under hats and helmets. Severe physical harm may result if loose clothing, jewelry or hair is caught in rotating tires.
- **Always wear safety glasses and batting helmets while the wheels are rotating.** Debris on the tires can fly off and cause physical harm. Everyday eyeglasses have only impact-resistant lenses; they are NOT safety glasses.
- **Never touch rotating tires.** Do not put hands or fingers into ball feed chute. Hands and fingers should only go to the edge of the chute.
- **Inspect machine before every use.** If damaged, have repaired by a qualified JUGS service technician.
- **Inspect tires before every use.** Be sure tires are free of grit and debris before turning on machine. Check tire pressure.
- **Do not use machine if ON/OFF switch does not work.** In the unlikely event that the switch becomes defective, have it replaced by a qualified JUGS service technician.
- **Keep machine clean, and free of grit and dirt.** With the machine unplugged, use only a clean damp cloth for cleaning. Never use brake fluids, gasoline, petroleum-based products, or any solvents to clean machine.

Rules For Safe Operation

- **To protect the operator, a protective screen must be placed in front of the cricket machine.**
- **Only operate and store this cricket machine in a clean, dry location.** Do not use outdoors if it is raining. If machine becomes wet, do not use. A potential shock hazard exists if this machine is used while or after it has been exposed to water. Hand dry surface water from machine with a clean cloth and allow the machine to completely air dry before its next use.
- **Avoid awkward operations and hand positions where a sudden slip could cause your hand to move into the rotating tires. ALWAYS make sure you have good footing and balance.**
- **Replacement parts.** All repairs, whether electrical or mechanical, should be made by a qualified JUGS service technician. When servicing, use only JUGS replacement parts.
- **Do not operate this machine under the influence of drugs, alcohol, or any medication.**
- **Stay alert and exercise control.** Watch what you are doing and use common sense. Do not operate this machine when you are tired. Do not rush.
- **Avoid accidental starting when reconnecting to a power supply.** Always turn off machine before disconnecting it from power source. Never leave machine running unattended. Turn the power off. Do not leave machine until tires come to a complete stop.

⚠ WARNING: Do not allow your familiarity with the machine to cause you to be careless. Remember that a careless fraction of a second is enough time to inflict severe injury to yourself or others.

SAVE THIS MANUAL: Refer to it often and use it to instruct other users. Do not loan your cricket machine to anyone who has not been instructed in its use. If you do loan your machine, be sure this manual goes with it.

Electrical

Grounding Instructions

This product must be grounded. If it should malfunction or break down, grounding provides a path of least resistance for electric current to reduce the risk of electric shock. This product is equipped with a cord having an equipment-grounding conductor and grounding plug. The plug must be connected to an appropriate GFCI outlet that is properly installed and grounded in accordance with all local codes and ordinances.

Do not modify the plug provided. If it will not fit the outlet, have the proper outlet installed by a qualified electrician. Improper connection of the equipment-grounding conductor can result in a risk of electric shock. The conductor with insulation having an outer surface that is green with or without yellow stripes is the equipment-grounding conductor. If repair or replacement of the electric cord or plug is necessary, do not connect the equipment-grounding conductor to a live terminal.

Check with a qualified electrician or service personnel if the grounding instructions are not completely understood, or if in doubt as to whether the pitching machine is properly grounded.

Extension Cords

Use only 3-wire 16 AWG or larger grounding type extension cords that have 3-prong grounding plugs and 3-pole receptacles that accept the machine's plug. When using the machine at a considerable distance from a power source, use an extension cord heavy enough to carry the current that the machine will draw. An undersized extension cord will cause a drop in line voltage, resulting in a loss of power and causing the motor to overheat. Only round jacketed cords listed by Underwriter's Laboratories (UL) should be used.

When working with the machine outdoors, use an extension cord designed for outside use. This is indicated by the letters "WA" on the cord's jacket. Before using the extension cord, inspect it for loose or exposed wires and cut or worn insulation.

Electrical

⚠ WARNING: Keep the cord away from the rotating tire area. Repair or replace a damaged or worn cord immediately.

Electrical Connection:

Your JUGS BP™2 Cricket Bowling Machine is powered by two 90 volt motors (180 for 220V.) Do not operate this machine on direct current (DC). A substantial voltage drop will cause a loss of power and the motor will overheat. If the machine does not operate when plugged into an outlet, double check the power supply. Your pitching machine will operate under a standard 110/220 voltage AC outlet. Do not use an adapter with this product.

This machine is intended for use on a circuit that has an outlet like the one shown in Figure 2. It also has a grounding pin like the one shown.

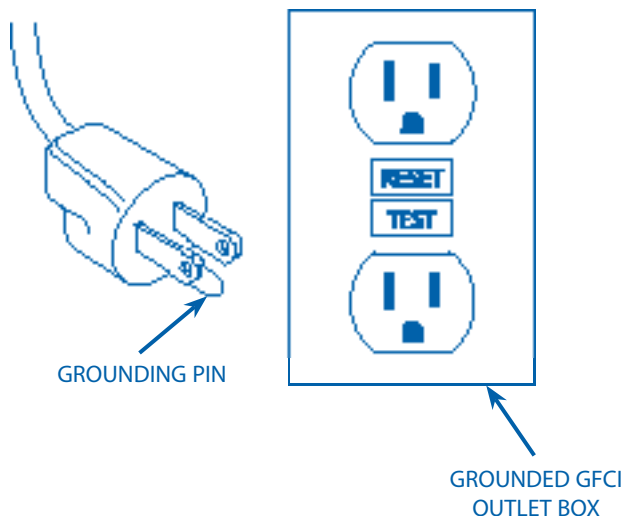

Figure 2

Terminology

JUGS BP[®]2 Cricket Bowling Machine

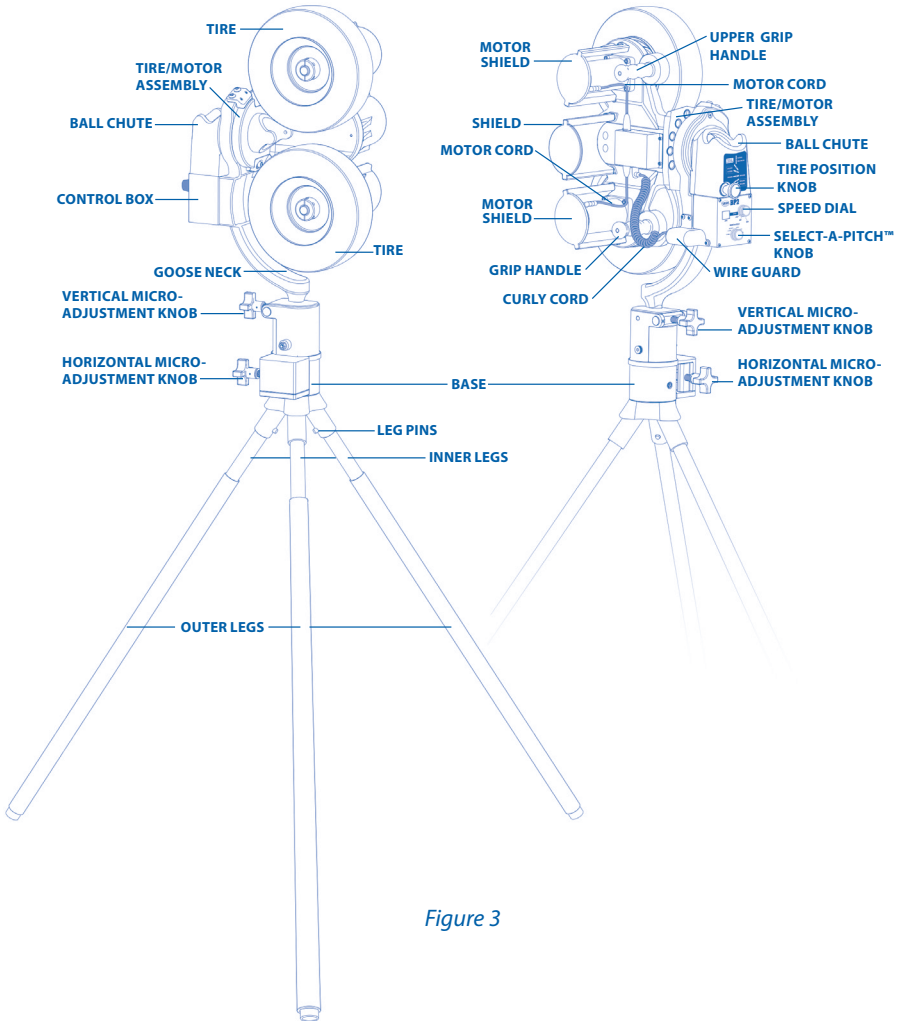

Figure 3

Unpacking

⚠ WARNING: To prevent accidental starting or electrical shock that could cause possible serious injury, assemble all parts to your machine before connecting it to the power supply. The bowling machine should never be connected to a power supply when you are assembling parts, making adjustments, cleaning, servicing, or when not in use.

- Carefully lift machine from carton and place on level surface.
- Make sure you have all the parts (See Figure 3). If any parts are missing, do not operate the machine until the missing parts are replaced. Failure to do so could result in possible serious personal injury.
- Do not discard the packing materials until you have carefully inspected the machine, identified all the parts, and satisfactorily operated the machine.

NOTE: If any parts are damaged or missing, do not attempt to plug in the power cord and turn on switch until the damaged or missing parts are obtained and are installed correctly.

Set Up

JUGS Adjustable Cricket-Bowling-Machine Legs

Includes the following:

- Three, sturdy, 46" steel hollow inner legs
- Three, sturdy, 47" steel hollow outer legs
- Three 1/2" -13 x 2 1/4" hex bolts
- Three 1/2" -13 hex nuts
- Three 1/2" -13 x 3/4" hex flange bolts
- Three crutch tips for indoor use
Features:
- Three height adjustments for different levels of play
- Retractable design for easy transportation
- Dual bolts for a safe and sturdy leg base

Setup

Your JUGS Cricket machine is equipped with three 2-piece adjustable legs for different levels of play.



Delivery Heights

- **Position 1**

Total Leg Length: 69.5 inches (176 cm)

Hole 1



For **junior-level** play, slide inner legs all the way until hole #1 lines up with the outer leg hole (see illustration above). Insert one 1/2" x 2 1/4" hex bolt through both legs. Place one 1/2" hex nut on end of bolt and tighten. Tighten the flange bolt as well (see figure 4).

- **Position 2**

Total Leg Length: 75 inches (190 cm)

Hole 2



For **college-level** play, slide inner legs all the way until hole #2 lines up with the outer leg hole (see illustration above). Insert one 1/2" x 2 1/4" hex bolt through both legs. Place one 1/2" hex nut on end of bolt and tighten. Tighten the flange bolt as well (see figure 4).

- **Position 3**

Total Leg Length: 83.5 inches (212 cm)

Hole 3



For **test-level** play, slide inner legs all the way until hole #3 lines up with the outer leg hole (see illustration above). Insert one 1/2" x 2 1/4" hex bolt through both legs. Place one 1/2" hex nut on end of bolt and tighten. Tighten the flange bolt as well (see figure 4).

- Total height (surface to top of vertical wheel) is 96 inches (244 cm).
- Set of Cricket legs weighs 43 lbs (19.5 kilos).
- Use a 3/4-inch (19 mm) wrench for hex-head bolts and nuts.

Setup

1. With the machine flat on the ground, attach legs by inserting pinned end of legs (3 total) into base until pins are completely engaged
2. Place rubber crutch tips on lower end of legs if BP®2 is to be used indoors. The leg crutch tips are not recommended for outdoor use.
3. Lift the cricket machine upright.

IMPORTANT: Always set up the cricket machine so that the two legs are positioned in front, facing the pitching screen and batter, and one leg facing back toward the operator.

4. Check speed dial and make sure that it is in full counter-clockwise position —pointer at OFF position. (Figure 5.)
5. Plug heavy-duty, No. 18 gauge three-prong, extension cord into 110-volt GFCI outlet (220-volt for 220V models) and connect to short cord on pitching machine. Place a pitcher's screen in front of the cricket machine to protect the operator and the cricket machine from batted balls.

⚠ WARNING: Make sure that the Tire Position Knob is fully engaged before operating machine.

Transporting

- To move the BP®2, make sure machine is locked in fast/medium pace position, slowly tip machine over until tires rest on the ground. Grasp and lift two legs and roll on wheels to new position as you would a wheelbarrow. The JUGS BP®2 will fit in the trunk of a car by removing its legs.
- Do not roll tires on surfaces that might damage the tire. If the tire becomes deformed, flat, or damaged, it must be repaired before using the machine. (See tire specifications, Page 24 and 25.)

⚠ WARNING: Never leave cricket machine unattended.

Operation

1. Operators of JUGS Cricket Machines must wear safety glasses and batting helmets at all times.
2. Check speed dial and make sure that it is in full counter-clockwise position —pointer at OFF position. (See figure 5.)
3. For either 110V or 220V, plug heavy-duty no. 18 gauge three-prong extension cord into an AC outlet and connect to short cord on cricket machine. Place the bowler's screen in front of the cricket machine to protect the operator and the cricket machine from batted balls.
4. Position machine at desired distance from target.
5. Turn Speed Dial to desired speed.
6. Have all batters and observers stand well clear of the target as you deliver practice balls. **To adjust trajectory, use the Vertical Micro-Adjustment Knob. To adjust in and out (right or left), use the Horizontal Micro-Adjustment Knob** (see figure 4b.) It is normal to feed five or six balls before arriving at the setting you desire. Always have the batter stand clear while adjusting your JUGS cricket machine.

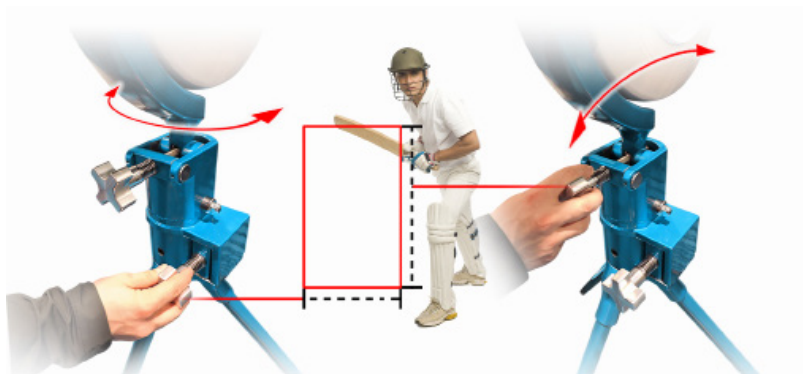

Figure 4b. Micro-Adjustment Knobs

7. At the beginning of practice, or after any change in speed, curve, or trajectory, have the batter stand well clear while at least one test ball is fed to make sure the ball is delivered at the desired target. If you move the machine for any reason, repeat this process.
8. Deliver balls at speeds the batter can learn to hit. As the batter's skills increase you can bowl faster deliveries.

Operation

9. When you increase speed of any delivery, using the Vertical Micro-Adjustment Knob, you must lower elevation of aim; when you decrease speed, you must increase the aim elevation. Use the Vertical Micro-Adjustment Knob to change the elevation up or down.
10. Space all deliveries approximately six seconds apart. Try to get the batter to regard each delivery as a “separate” ball and not to be an “automatic” swinger.
11. Always “show” the ball to batter. When you are certain the batter has acknowledged that he or she is ready, set ball in feed chute and release. Do not drop the ball into the chute.
12. Do not permit more than one or two persons around the cricket machine during its operation.
13. Do not permit the cricket machine to fall on its wheels. This could result in non-warranty damage.
14. Check tightness of all bolts and nuts at regular intervals. If any looseness, vibration, or rattle is noticed, correct immediately before further use.
15. Always turn speed dial to the full counter-clockwise position—pointer at OFF position, when throwing is completed or temporarily stopped.

⚠ WARNING: A protective screen must be used to protect the operator and the machine from batted balls.

NOTE: We suggest that each operator spend a couple of hours experimenting with the JUGS cricket machine. Try many different speed settings. Do not be afraid that any setting you make will harm the cricket machine; however, you should use a wide backstop when experimenting with faster speeds.

Operation

Bowling to Batters

Follow all safety performance instructions in this manual. The following feeding instructions should be used to insure accurate and efficient operation of the JUGS cricket machine.

Important Cricket Machine Feeding Instructions:

- When feeding the machine with official leather cricket balls, hold the ball the same way every time.
- Have all batters and observers stand well clear of the target as you bowl test balls to adjust trajectory and aiming point.
- **VERY IMPORTANT:** Before you place the ball in the feeding chute, you should look up at the batter and make absolutely sure the batter is watching you and is ready to receive the delivery. It is extremely important that you make sure that the immediate area in front of the bowling machine and the flight path of the ball is clear before you feed the balls into the bowling machine.
- When the batter has taken his/her stance and indicates he or she is ready to hit, hold the ball high in the air where the batter can see the ball. Then bring the ball down to the chute simulating live action so that the batter can time the ball correctly. Set the ball in the feed chute and release. Do not drop the ball into the chute. Watch the ball into the wheels, then look up at the batter. The whole feeding operation should be smooth and without interruption.
- Every batter, after taking his/her stance, as well as between deliveries, goes through a personal readiness routine. The ball feeder should adjust the delivery spacing to each batters' habits accordingly. This will assure that the batter is ready to receive the delivery and will also help to simulate live action. The batter can then regard each delivery as a separate ball and avoid becoming an "automatic swinger". Generally speaking, deliveries can be spaced between 6 and 10 seconds apart.

Operation

- Out-of-round, soft, mushy, or wet balls will affect accuracy of deliveries and must not be used. Mixing different types of balls (leather, rubber, JUGS, etc.) will affect consistency of deliveries. For best accuracy, feed only one type of ball at a time.
- Use only JUGS Dimpled-Style Cricket balls, or regulation size cricket balls.
- Do not permit more than one or two persons around the cricket machine during its operation.

BATTING HELMETS MUST BE WORN AT ALL TIMES.

- Operators of JUGS Cricket Machines must wear safety glasses and batting helmets at all times.



Figure 5. Control Panel

Operation

Bowling Different Deliveries: Tire Position Adjustment

When your machine arrives it is in the fast/medium pace tire position. Changing from one delivery to another is done by simply following these three steps.

1. With one hand firmly hold the Top Handle
2. While holding the Top Handle, using your free hand, pull the Tire Position Knob out, disengaging it from the Tire/Motor Assembly. (figure 6.)
3. Using the Tire Position diagram located on the face of the Feed Chute, rotate the Tire/Motor Assembly to the desired position and reengage the Tire Position Knob by pushing it in all the way. The Tire/Motor Assembly should now be locked in the tire position for the desired delivery.

There are six wheel positions to choose from (figure 6b.)

⚠ WARNING: When disengaging the Tire Position Knob, the Tire/Motor Assembly will want to swing freely. To avoid injury, a solid grip is required before disengaging the Tire/Motor Assembly and must be maintained until the Tire/Motor Assembly is reengaged with the Tire Position Knob fully inserted. (figure 6a.)



Figure 6.



Figure 6a.

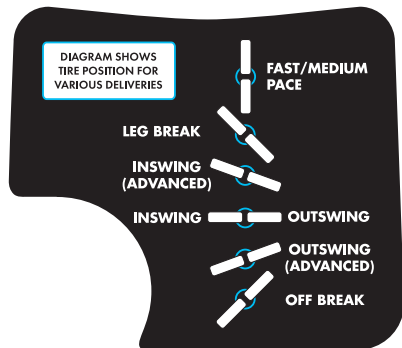

Figure 6b. Tire Positions

Operation

Bowling Different Deliveries: FAST/MEDIUM PACE

Note: Speeds may vary and are shown as examples only.

DELIVERY:

TIRE POSITION:

LOW



RISING



Operation

Bowling Different Deliveries: LEG BREAK/ADVANCED INSWING

Note: Speeds may vary and are shown as examples only.

DELIVERY:

TIRE POSITION:

LEG BREAK

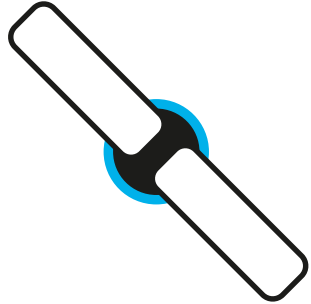

ADVANCED INSWING

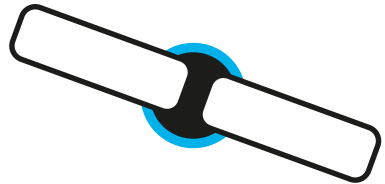

Operation

Bowling Different Deliveries: INSWING/OUTSWING

Note: Speeds may vary and are shown as examples only.

DELIVERY:

TIRE POSITION:

INSWING



OUTSWING



Operation

Bowling Different Deliveries: **ADVANCED OUTSWING/OFF BREAK**

Note: Speeds may vary and are shown as examples only.

DELIVERY:

TIRE POSITION:

ADVANCED OUTSWING

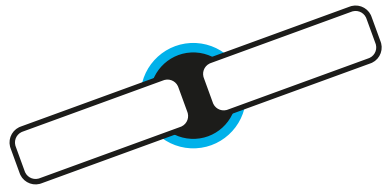

OFF BREAK

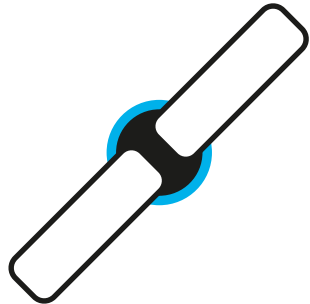

IMPORTANT: You may have to vary speeds slightly from the examples to get the desired accuracy and consistency.

Operation

NOTE: We suggest that each operator spend a couple of hours experimenting with the JUGS Cricket Machine. Try many different speed settings. Do not be afraid that any setting you make will harm the bowling machine; however, you should use a wide backstop when experimenting with faster speeds.

- At the beginning of practice, or after any change in speed, delivery, or trajectory, have the batter stand well clear while at least one test ball is thrown to make sure the ball is thrown at the desired target. If you move the machine for any reason, repeat this process.
- Bowl balls at speeds the batter can learn to hit. As the batter's skills increase you can throw faster deliveries.
- When you increase speed of any delivery, using the Vertical Micro-Adjustment Knob, you must lower elevation of aim; when you decrease speed, you must increase the aim elevation. Use the Vertical Micro-Adjustment Knob to change the elevation up or down.
- Do not permit the bowling machine to fall on its wheels. This could result in non-warranty damage.
- Check tightness of all bolts and nuts at regular intervals. If any looseness, vibration, or rattle is noticed, correct immediately before further use.
- Always turn speed dial to the full counter-clockwise position—pointer at OFF position, when throwing is completed or temporarily stopped.

⚠ WARNING: A protective screen must be used to protect the operator and the machine from batted balls.

IMPORTANT: If machine becomes wet during practice, turn off machine immediately, and transport it to a clean, dry location. Dry surface water with a soft, clean cloth and permit machine to completely air dry before next use.

Product Specifications

JUGS BP®2 Specifications:

Motor Specifications:

Variable Speed	110v 45-90 mph, 220v 72 – 150 kph
Maximum developed horse power	1/8 hp
Volts	90vDC, 110V, (180vDC, 220V)
Amps	3 amps, 110V, (1.5 amps, 220V)
Hertz	50/60 Hz
RPM (no load)	4500 rpm
Overload protection	yes

Tire Specifications:

Size	4.10/3.50-6
Pressure	26 PSI, 180 kpa

Frame Specifications:

Legs	steel tubing
Motor Mount and Base	cast aluminum
Ball Feed Chute	cast aluminum
Overall Height	96 in. (244 cm)
Overall Width	75 in. (190 cm)
Overall Weight	179 lbs. (81 kg)
Recommended Generator	Portable Inverter Generator - 2000W
Recommended Balls	JUGS Dimpled Cricket Balls or Leather Balls

IMPORTANT: Servicing requires extreme care and knowledge of the machine and should be performed only by JUGS. For service, we suggest you return the machine to JUGS for repair. Always use original factory replacement parts when servicing.

Some parts can be purchased online at: jugssports.com/Parts-and-Service, or call direct at: 1-800-547-6843.

Maintenance

Review the following instructions carefully to maintain maximum accuracy with your JUGS Cricket Bowling Machine.

- Maintain tire pressure at 26 PSI/180 kpa.

Cleaning

- Keep machine clean, and free of grit and dirt. Always use a clean damp cloth when cleaning. Never use brake fluids, gasoline, petroleum-based products, or any solvents to clean machine.
- Periodically, you must clean the tires to help maintain their maximum performance. A dirty tire can easily be distinguished by either a dark ring around the tire surface or when the surface itself has turned yellow and has a very glossy or shiny finish.
- In order to begin cleaning you must first inflate the tires to approximately 26 PSI/180 kpa.
- Take medium grade sandpaper (sometimes an even coarser grade is necessary depending on the amount of soil buildup) and begin to scrub the tire surface as you would a very dirty frying pan. This process can be very tedious and could take up to 10 minutes per tire. However, it is necessary in order to completely clean the rubber of all foreign substances, as well as prepare it for better machine performance. You should sand the tires whenever you notice the soil build-up forming. Always sand tires with the power switch OFF and the machine unplugged.

Once you complete this operation the tire surface will, in most cases, take on the white color it was originally. Maintaining the tire in this fashion will not only maximize the performance and accuracy of your machine, but it will extend the life of the tire.

Storage

- Always store machine and extension cord in separate, clean, dry secured areas. Cover the machine with a suitable dust cover that does not retain moisture. Do not use plastic.

Warranty

JUGS Sports guarantees that the JUGS® Machines are well made; of good materials, and workmanship; and agrees that if, within two years after shipment thereof, any part so guaranteed should fail because of defective material or workmanship in its manufacture, the Company will repair or replace such part, free of charge F.O.B. to its factory in Tualatin, Oregon; provided, however, that upon request, the Buyer shall return the allegedly defective part to the Company's factory with transportation charges thereon prepaid. Commercial use of any JUGS product automatically limits this warranty to 30 days after date of shipment.

This warranty shall not be effective if the equipment has been subject to misuse, negligence or accident, nor if the equipment has been repaired or altered outside of our Tualatin factory in any respect which, in judgement, affects its condition or operation.

In the USA and Canada, call toll free: **1-800-547-6843**.

Please return card below to JUGS Sports.

Warranty Record

JUGS SERIAL No.

Date Delivered:

Model: **JUGS BP®2 Cricket Bowling Machine (110v M1960),(220v M2960)**

Name:

Address:

Zip:

Phone:

Email:

Purchased From:

Type of Activity (Youth League, College, or Test Level of Play):

Coach/Manager Name:



Internationally, call collect: 0-503-692-1635.

Our fax number is: 503-691-1100.

jugssports.com

Model: _____

Serial No: _____

Date Delivered: _____

• SAVE THIS PORTION FOR YOUR RECORDS •

PLACE
STAMP
HERE

JUGS, Inc.
P.O. Drawer 365
Tualatin, Oregon 97062

If you need more information about this product or any other JUGS product or service, please contact the manufacturer:



In the USA and Canada,
call toll-free:
1-800-547-6843.

For International Orders,
call collect:
0-503-692-1635.

Our fax number is
1-503-691-1100.

Visit our website at
jugssports.com

Se habla español