



# OWNER'S MANUAL

## Instructions for the **JUGS** Soccer Machine

Part No. M1800



**SAVE THIS MANUAL**

**ATTENTION,  
Coaches and Operators  
of the JUGS Soccer Machine:**

This manual must be kept with the soccer machine  
**AT ALL TIMES.**

Each coach and/or operator  
must read and understand the instructions in this manual  
**BEFORE USING**  
the JUGS Soccer Machine.

Call 1-800-547-6843 or 503-692-1635  
if you need additional copies.

# Table of Contents

Introduction.....	2
Product Safety Signs and Labels.....	3
Rules for Safe Operation.....	5
Electrical.....	8
Terminology.....	10
Unpacking.....	11
Transporting.....	11
Operation.....	12
Drills.....	16
Maintenance.....	21
Product Specifications.....	22
Operator Notes.....	23
Warranty Information.....	27

# Introduction

Your new JUGS soccer machine has been checked for quality and craftsmanship. Its innovative design is backed by three decades of research, development and manufacturing experience. It has many features, designed to make your practices more efficient and enjoyable. Safety, performance and dependability have been given top priority in the design of all JUGS ball-throwing machines, making them easy to operate and maintain. With proper care, your JUGS soccer machine will give you many years of enjoyable service.



At JUGS, we are committed to providing our customers with safe, dependable products. Your comments are always welcome, and they help us to continue to be the #1 producer of ball-throwing machines in the world. Call or write to JUGS to tell us what you think.



# Product Safety Signs & Labels

## Safety Alert Symbols

Safety Alert Symbols indicate DANGER, WARNING or CAUTION. These symbols may be used in conjunction with other symbols or pictographs. Failure to obey a safety warning will result in serious injury to yourself or to others. Always follow the safety precautions to reduce the risk of electric shock and personal injury.

-  **DANGER:** Indicates an imminently hazardous situation which, if not avoided, will result in death or serious injury. This signal word is to be limited to the most extreme situations.
-  **WARNING:** Indicates a potentially hazardous situation which, if not avoided, could result in death or serious injury.
-  **CAUTION:** Indicates a potentially hazardous situation which, if not avoided, may result in minor or moderate injury. It may also be used to alert against unsafe practices.

## Product Safety Signs and Labels

The purpose of product safety signs and labels is to attract your attention to possible dangers. The safety symbols, signal words and the explanations with them, deserve your careful attention and understanding. The safety warnings do not by themselves eliminate any danger. The instructions or warnings they give are not substitutes for proper accident-prevention measures.



# Safety Signs and Labels

Carefully read all safety-sign decals affixed to machine before operating your JUGS Soccer Machine. See some typical examples below.



Figure 1

# Rules For Safe Operation

-  **WARNING:** JUGS soccer machines are intended for use by operators who are at least 18 years of age and who have been instructed in their use.
-  **WARNING:** Do not attempt to operate this machine until you have read thoroughly and understand completely all instructions, safety rules (contained in this manual), machine labels, etc. Failure to comply can result in accidents involving electric shock or serious personal injury. Save this Owners Manual and review frequently for continuing safe operation, and for instructing others who may use this machine.
-  **WARNING:** Do not connect your ball-throwing machine to a power source until you have assembled and adjusted the machine as described in this manual and have read and understood all precautions and operating instructions in the manual and printed on the machine.

## READ THIS MANUAL:

- **Know your soccer machine.** Read the Owner's Manual carefully. Learn the machine's capabilities, features and limitations—as well as the specific potential hazards related to this machine.
- **Guard against electrical shock** by preventing body contact with grounded surfaces. For example: radiators, pipes, fences or other enclosures.
- **Keep the operator's area free of clutter.** Pick up all loose balls around the machine and keep the ball supply in a pail, bucket or other suitable container. Cluttered operating areas invite accidents.
- **Do not allow children to operate the soccer machine. You must be at least 18 years of age or older** and instructed in the proper operation, maintenance, care and storage of this machine before operating it. Close supervision is necessary when this machine is used near children.
- **Use the right ball.** Out-of-round, soft, mushy, or wet balls will affect the accuracy of tosses and must not be used. Mixing different types of balls (leather, rubber, etc.) will also affect consistency of tosses. Use only one ball type at a time.

# Rules For Safe Operation

- **Inspect extension cords periodically** and replace them if damaged.
- **Use the proper extension cord.** Make sure your extension cord is in good condition. When using an extension cord, be sure to use one heavy enough to carry the current your machine will draw. An undersized cord will cause a drop in line voltage, resulting in loss of power and overheating. A wire gauge size (AWG) of at least 16 is recommended for an extension cord 25 feet or less in length. If in doubt, use the next heavier gauge. The smaller the gauge number, the heavier the cord.
- **Do not abuse the cord.** Never yank a cord to disconnect it from receptacle. Keep cord away from heat, oil and sharp edges. Stay constantly aware of the cord location and keep it well away from the rotating tires.
- **Dress properly.** Do not wear loose clothing, neckties, rings, bracelets, or other jewelry. They can get caught and draw you into the moving parts. Long hair should be tied up and tucked under hats and helmets. Severe physical harm may result if loose clothing, jewelry or hair is caught in rotating tires.
- **Always wear safety glasses (or goggles) while the wheels are rotating.** Debris on the wheels can fly off and cause physical harm. Everyday eyeglasses have only impact-resistant lenses; they are NOT safety glasses.
- **Never touch rotating wheels.** Do not put hands or fingers into ball- feed chute. Hands and fingers should only go to the edge of the chute.
- **Do not permit the soccer machine to fall on its wheels.** This could result in non-warranted damage.
- **Inspect the machine before every use.** If damaged, have it repaired by a qualified JUGS service technician.
- **Inspect the wheels before every use.** Be sure the wheels are free of grit and debris before turning on the machine.
- **Do not use machine if the ON/OFF switch does not work.** In the unlikely event that the switch becomes defective, have it replaced by a qualified JUGS service technician.



# Rules For Safe Operation

- **Keep the machine clean, and free of grit and dirt.** With the machine unplugged, use only a clean, damp cloth for cleaning. Never use brake fluids, gasoline, petroleum-based products or any solvents to clean the machine.
- **Tighten the elevating locking knob securely** after adjusting the trajectory.
- **Do not permit more than one or two persons** around the soccer machine during its operation.
- **Operate and store this soccer machine only in a clean, dry location.** Do not use it outdoors if it is raining. If machine becomes wet, do not use it. A potential shock hazard exists if this machine is used while or after it has been exposed to water. Hand-dry surface water from the machine with a clean cloth and allow the machine to completely air dry before its next use.
- **Avoid awkward operations and hand positions** where a sudden slip could cause your hand to move into the rotating wheels. **ALWAYS** make sure you have good footing and balance.
- **Use only JUGS technicians and JUGS replacement parts.** All repairs, whether electrical or mechanical, should be made by a qualified JUGS service technician. When servicing, use only JUGS replacement parts.
- **Do not operate this machine under the influence of drugs, alcohol, or any medication.**
- **Stay alert and exercise control.** Watch what you are doing and use common sense. Do not operate this machine when you are tired. Do not rush.
- **Avoid accidental starting when reconnecting to a power supply.** Always turn off the machine before disconnecting it from a power source. Turn off the power and unplug the power cord. Do not leave the machine until tires come to a complete stop.
- **Always unplug the machine when it is not in use.**

**⚠ WARNING:** Do not allow your familiarity with the machine to cause you to be careless. Remember that a careless fraction of a second is enough time to inflict severe injury on yourself or others.

**SAVE THIS MANUAL.** Refer to it often and use it to instruct other users. Do not loan your soccer machine to anyone who has not been instructed in its use. If you do loan your machine, be sure this manual goes with it.

# Electrical

## Grounding Instructions

This product must be grounded. If it should malfunction or break down, grounding provides a path of least resistance for electric current to reduce the risk of electric shock. This product is equipped with a cord having an equipment-grounding conductor and grounding plug. The plug must be connected to an appropriate GFCI outlet that is properly installed and grounded in accordance with all local codes and ordinances.

Do not modify the plug provided. If it will not fit the outlet, have the proper outlet installed by a qualified electrician. Improper connection of the equipment-grounding conductor can result in a risk of electric shock. The conductor with insulation having an outer surface that is green with or without yellow stripes is the equipment-grounding conductor. If repair or replacement of the electric cord or plug is necessary, do not connect the equipment-grounding conductor to a live terminal.

Check with a qualified electrician or service personnel if the grounding instructions are not completely understood or if you are in doubt as to whether the soccer machine is properly grounded.

## Extension Cords

Use only 3-wire 16-AWG or larger grounding-type extension cords that have 3-prong grounding plugs and 3-pole receptacles that accept the machine's plug. When using the machine at a considerable distance from a power source, use an extension cord heavy enough to carry the current that the machine will

draw. An undersized extension cord will cause a drop in line voltage, resulting in a loss of power and causing the motor to overheat. Only round-jacketed cords listed by Underwriter’s Laboratories (UL) should be used.

When working with the machine outdoors, use an extension cord designed for outside use. This is indicated by the letters “WA” on the cord’s jacket. Before using the extension cord, inspect it for loose or exposed wires and cut or worn insulation.

**⚠ WARNING:** Keep the cord away from the rotating tire area. Repair or replace a damaged or worn cord immediately.

## Electrical Connection

Your JUGS soccer machine is powered by a 90 volt motor(s). Do not operate this machine on direct current (DC). A substantial voltage drop will cause a loss of power and the motor will overheat. If the machine does not operate when plugged into an outlet, double check the power supply. Your soccer machine will operate under a standard 110 voltage AC outlet. Do not use an adapter with this product.

This machine is intended for use on a circuit that has an outlet like the one shown in Figure 2. It also has a grounding pin like the one shown.

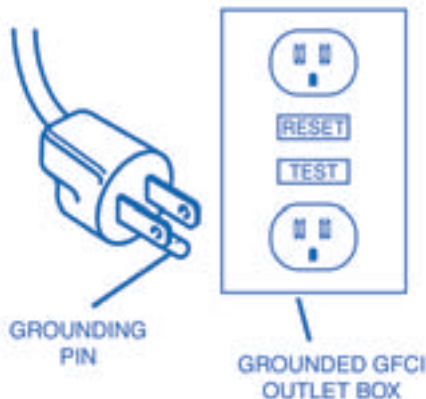

Figure 2

# Terminology

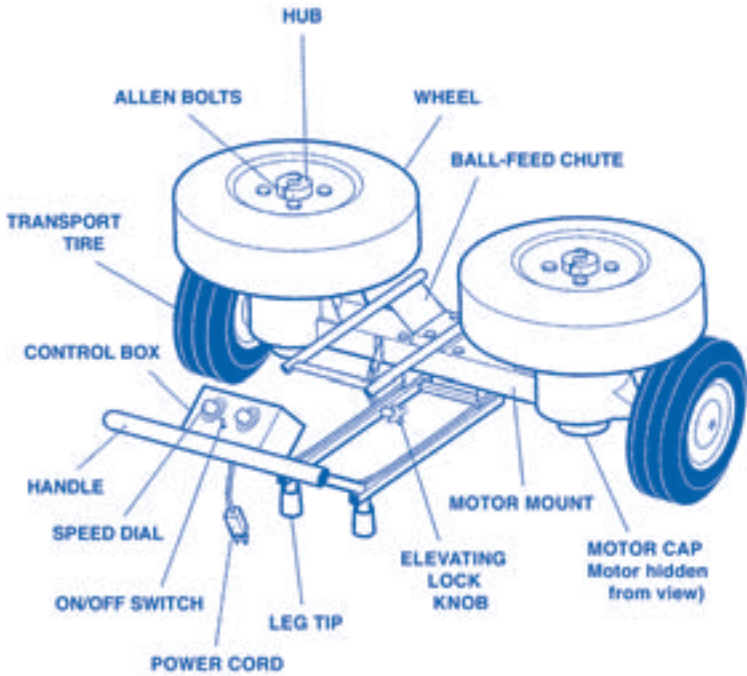

Figure 3

# Unpacking

**⚠ WARNING:** To prevent accidental starting or electrical shock that could cause possible serious injury, assemble all parts to your machine before connecting it to the power supply. The soccer machine should never be connected to a power supply when you are assembling parts, making adjustments, cleaning, servicing or when not in use.

1. Carefully lift the machine from its carton and place it on a level surface.
2. Make sure you have all the parts (See Figures 3). If any parts are missing, do not operate the machine until the missing parts are replaced. Failure to do so could result in possible serious personal injury.
3. Do not discard the packing materials until you have carefully inspected the machine, identified all the parts and satisfactorily operated the machine.

## **NOTE:**

If any parts are damaged or missing, do not attempt to plug in the power cord and turn on the switch until the damaged or missing parts are obtained and are installed correctly.

# Transporting

1. Tighten the elevating-lock knob.
2. Grasp and lift the two legs. Roll the JUGS as you would a wheelbarrow.

# Operation

## GENERAL OPERATING INSTRUCTIONS

1. Check both dials and make sure each is in full counterclockwise position (pointer at “0”) and that the control switch is in the “OFF” position.
2. Plug a heavy-duty, No.16-gauge 3-wire extension cord (3-prong) into a grounded (3-prong) 110-volt AC outlet and connect it to the short cord on the soccer machine. You are now ready to throw.
3. Loosen the elevating lock knob on the bottom of the handle, aim at the target, adjust the height and tighten the knob. This allows you to adjust the trajectory. You will have to practice this so you will know approximately where it should be set for each type of throw.
4. Move the control switch to the “ON” position. Gradually turn the right-hand dial to the full clockwise position. The right wheel will be turning rapidly clockwise and the left wheel will be turning more slowly counterclockwise.

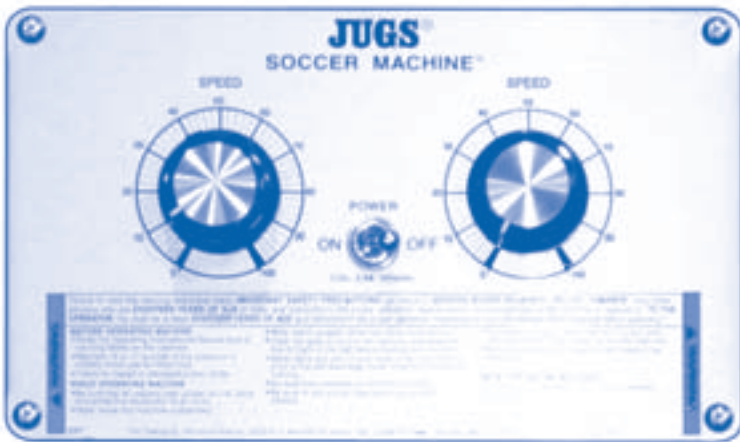

Figure 4. Control Panel

# Operation

## SOCCER MACHINE BALL-FEEDING INSTRUCTIONS

Follow all safety-performance instructions in this manual. The following ball-feeding instructions should be used to insure accurate and efficient operation of the JUGS soccer machine.

### Important Soccer Machine Ball Feeding Instructions.

1. Have all players and observers stand well clear of the target as you throw test balls to adjust the trajectory and aiming point. Always move the player away from the target area while making any direction or speed changes.
2. **VERY IMPORTANT:** Before you place the ball in the feed chute, you should look up at the player and make absolutely sure the player is watching you and is ready to receive the ball. It is **extremely important** that you make sure the immediate area in front of the soccer machine and the flight path of the ball is clear before you feed the balls into the soccer machine.
3. Place a ball in the Feed Chute and observe the trajectory. Loosen the elevating lock knob and adjust them until the desired trajectory is attained. It is normal to throw a few practice balls before arriving at the desired trajectory and speed setting.
4. When the player has taken his or her position and indicates he or she is ready, hold the ball high in the air where the player can see it. Then bring the ball down to the chute, simulating live action. Watch the ball as it goes toward the wheels, then look up at the player. Set the ball in the feed chute and push. The whole feeding operation should be smooth and without interruption.
5. Time the throws at intervals that are comfortable for the receiver. Always “show” the ball to the player, set it in the feed chute, and push.

# Operation

## DIAL SETTINGS FOR VARIOUS TOSSES

Figure 5, below, shows some typical speed-dial settings for the left and right wheels of the machine. These combinations will produce the type of kick shown—i.e., curves, straight balls and knuckleballs.

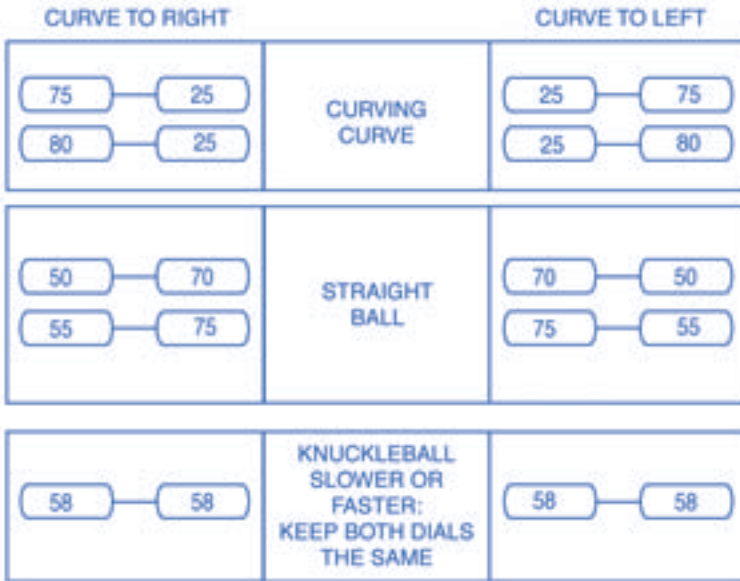

Figure 5

- To increase the speed of the ball, turn the dial for a slower-turning wheel (clockwise).
- To reduce the speed of the ball or to reduce the amount of curve, turn the dial counterclockwise for a faster-turning wheel. REMEMBER, the greater the speed differential between wheels, the greater the curve. Conversely, a small differential will result in a smaller curve. Equal speeds will result in a ball kick with little or no spin (knuckleball).
- A relatively straight ball can be thrown by maintaining a 20- to 30-point difference between the speed settings of the two wheels.



# Operation

- Be sure to try different settings. For example, when throwing a ball curving to the left, set the right-hand dial at 70, 75, or 80 and the left-hand dial at 30, 35, or 40. Observe the curve and the speed of the ball and the type of curve you want. Most coaches devise a table for the operators of the soccer machine to show what settings to use for any given practice.
- When you increase the speed of the ball, you must lower the elevation of the aim; when you decrease the speed of the ball, you must increase the elevation.

## IMPORTANT:

Always throw balls at speeds suitable for the age and skill level of the player. Balls thrown too fast will be counterproductive and dangerous.

## NOTE:

We suggest that each operator spend as much time as needed experimenting with the JUGS Soccer machine. (You may want to jot down the wheel position and speed-dial settings in the space provided on pages 23-26, for future reference). Try many different speed settings. Do not be afraid that any setting you make will harm the soccer machine; however, you should use a wide backstop when experimenting with faster speeds.

At the beginning of practice, or after any change in speed or trajectory, have the player stand well clear while a sufficient number of test balls are thrown to make certain the machine is properly aimed at the intended target. If you move the machine for any reason, repeat this process.

 **WARNING:** It is possible for a random ball to enter the ball-feed chute on its own and hit the wheels—and possibly cause injury. Someone must stand next to the machine at all times and keep random balls from entering the chute.

# Operation

## GOALKEEPER SOCCER DRILLS

### 1. Shot Saving

Most coaches will look to the JUGS soccer machine as a device for providing accurate power shots for training goalkeepers.

The JUGS machine's ability to shoot at controlled speeds, ranging from 60 to 100 mph, with incredible accuracy, cannot be duplicated at the same level by the human body without the risk of injury to the shooter. Therefore, the JUGS Soccer Machine is a very economical training device inasmuch as no time is wasted in returning inaccurate shots which go over the crossbar or are wide of the post. In addition, you can practice shot saving with just one player, a coach and a backup goalkeeper.

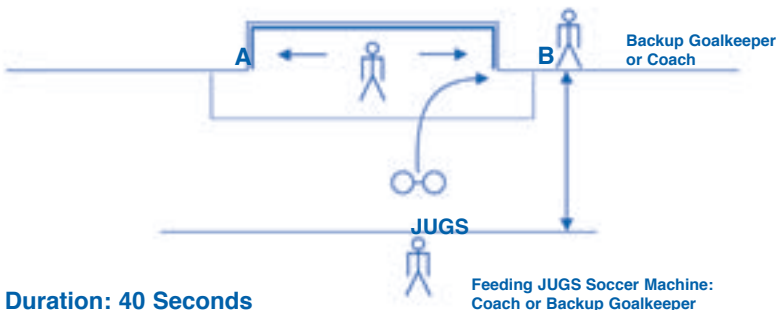

**Duration: 40 Seconds**

- A. The goalkeeper, from the center of the goal, races to touch the left post (A) with his right hand while then reacting to an outswinging shot from the JUGS machine to the right post (B).
- B. After 40 seconds' rest, during which time the second goalkeeper could take his turn, the goalkeeper repeats the exercise, changing the direction of his run and reaction-save to the opposite post.

# Operation

In each instance, the goalkeeper will do well to direct the outswing shot around the post for a corner if it cannot be held. The exercise can be altered to deliver balls at three different heights: low, medium and high. The backup goalkeeper can assume a position at the side of the post toward which shots are being directed, to assist in keeping balls in easy reach for rapid turnover during drills.

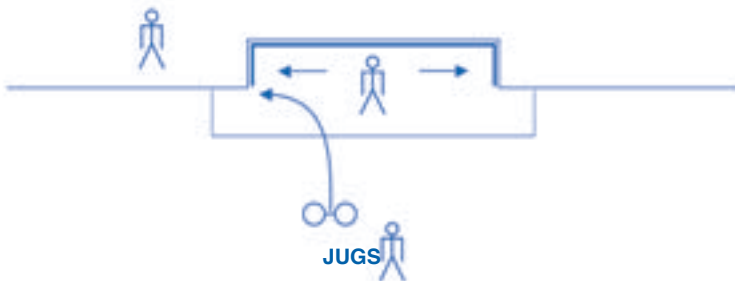

- C. Even more difficult for the goalkeeper, would be a similar exercise, where the shot is fired seemingly past the post by the JUGS machine, but with enough inswing to just catch the post and be knocked in. Often the spin on the ball will fool the goalkeeper in letting the shot go wide, which would be an unfortunate mistake.

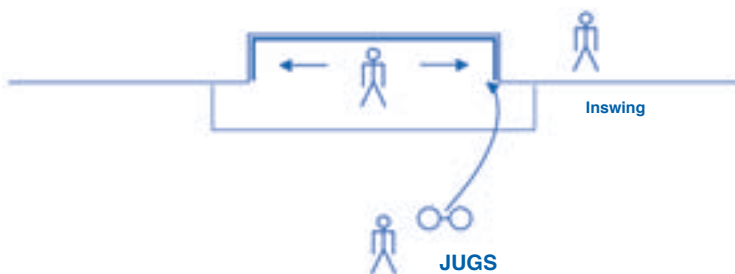

# Operation

- D. The ultimate training situation for shot saving and development of proper angle play would be with two JUGS Soccer machines, serving shots alternating to each post. The goalkeeper should work at top rate for a 40 second period then rest for a period of equal length.

The maximum number of such drills that should be done is ten to the right and ten to the left, for a total of 20. The total time used would be about 45 minutes, allowing for some extra time to change goalkeepers.

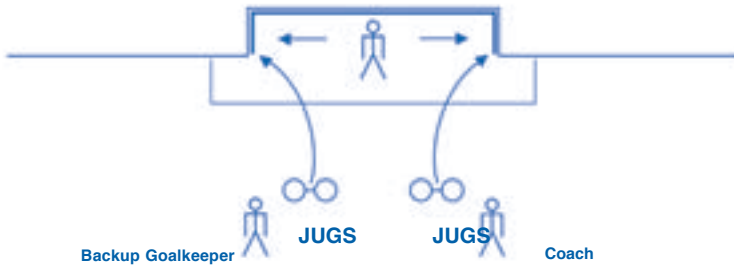

- E. In situations where a single JUGS machine is available, the coach could alternately serve balls from a position of six yards out, varying his serves accordingly.

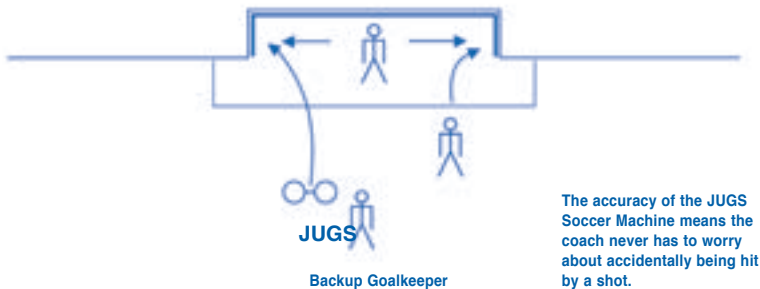

# Operation

## 2. Crosses and Corner Kicks

The JUGS Soccer Machine enables field players to place crosses accurately, which makes it ideal for goalkeepers who want to practice catching in traffic and boxing (punching).

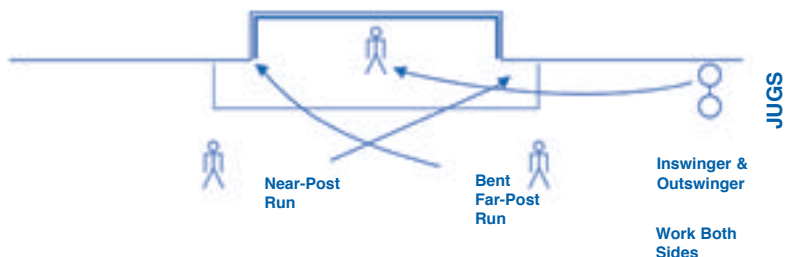

Both inswingers and outswingers may practice with or without the pressure of opposition or the aid of defenders.

The coach can build up the practice situation and increase the level of opposition and difficulty accordingly. The placement of the machine and nature of the cross can duplicate that of the next game's opponent, learned through scouting and properly prepare the team for that game situation.

In boxing the ball to change its direction, one or two hands may be used with the following principles in mind:

- Height
- Width
- Distance
- Accuracy

Boxing or immediately throwing a caught crossed ball to a designated player or area would be the ultimate tool for turning the play into a quick counterattacking situation.

# Operation

## 3. Indoor Soccer

Indoor soccer provides unique and diverse challenges for the goalkeeper, foremost of which is dealing with balls knocked around the boards to the goalkeeper. Often, these “crosses” take unusual dips or hops, and the goalkeeper must be ready to handle the ball cleanly, making a first-time catch or trap against the boards. Under no circumstances should the goalkeeper allow the ball to get past him or her, across the mouth of the goal.

This exercise is best practiced at the conclusion of the training session. Not many players would be interested in shooting a ball around the boards just to help the goalkeeper practice. The shot (pass) has to be hit hard at various levels; the glass or screen backboard provides different rebounds.

As in all technique training, the coach should not allow lack of fitness to interfere with proper performance of technique. In this particular exercise, it is the technique of catching and holding the ball which is important, and the goalkeeper should be given every opportunity to recover and correct mistakes both mentally and physically. At least 20 to 30 shots around the boards from each side, daily, will greatly enhance the goalkeeper’s ability to handle this type of situation unique, to indoor soccer.



# Maintenance

Review the following instructions carefully to maintain maximum accuracy with your JUGS Soccer Machine.

Maintain tire pressure at 16 to 17 psi.

## Cleaning

- **Keep the machine clean, and free of grit and dirt.** Always use a clean, damp cloth when cleaning. Never use brake fluids, gasoline, petroleum-based products, or any solvents, to clean the machine.
- Periodically, you must clean the wheel to help maintain its maximum performance. A dirty wheel can easily be distinguished by either a dark ring around the wheel surface or when the surface itself has turned yellow and has a very glossy or shiny finish.
- Using medium grade sandpaper (sometimes an even coarser grade is necessary, depending on the amount of soil buildup), begin to scrub the tire surface. This process can be very tedious and may take up to 10 minutes per tire. However, it is necessary to completely remove all foreign substances from the tires to prepare them for better machine performance. You should sand the tires whenever you notice the soil build-up forming. **Always sand tires with the power switch OFF and the machine unplugged.**

Once you complete this operation, the tire surface will, in most cases, take on the white color it was originally. Maintaining the tire in this fashion will not only maximize the performance and accuracy of your machine, but it will extend the life of the tire.

## Storage

- Always store the machine and extension cord in separate, clean, dry, secured areas. Cover the machine with a suitable dust cover that does not retain moisture. Do not use plastic.

# Product Specifications

## JUGS Soccer Machine Product Specifications

### Motor Specifications:

Variable Speed	
Maximum developed horsepower.....	1/4 hp
Volts.....	90vDC
Amps.....	3 amps
Hertz.....	50/60 Hz
RPM (no load).....	1900 rpm
Overload protection.....	yes

### Wheel Specifications:

Size.....	4.00/4.80-8
Pressure.....	16-17 psi

### Frame Specifications:

Legs.....	steel tubing
Motor-Mount and Leg-Clamp Casting.....	cast aluminum
Feed Chute.....	cast aluminum
Overall Width:.....	40 in.
Overall Height.....	23 in.
Overall Weight:.....	120 in.
Recommended Generator.....	Yamaha EF1000
Recommended Balls.....	regulation leather

### IMPORTANT:

Servicing requires extreme care and knowledge of the machine and should be performed only by JUGS. Therefore, we suggest you return the machine to JUGS for repair. Always use original factory replacement parts.



# Operator Notes

---

---

---

---

---

---

---

---

---

---

---

---

---

---

---

---

---

---

---

---

---

---

---

---

---

---







# Warranty

JUGS Sports guarantees that the JUGS® Pitching Machines are well made; of good materials, and workmanship; and agrees that if, within two years after shipment thereof, any part so guaranteed should fail because of defective material or workmanship in its manufacture, the Company will repair or replace such part, free of charge F.O.B. to its factory in Tualatin, Oregon; provided, however, that upon request, the Buyer shall return the allegedly defective part to the Company's factory with transportation charges thereon prepaid. Commercial use of any JUGS® product automatically limits this warranty to 30 days after date of shipment.

*This warranty shall not be effective if the equipment has been subject to misuse, negligence or accident, nor if the equipment has been repaired or altered outside of our Tualatin factory in any respect which, in our judgment, affects its condition or operation.*

↓ RETURN PERFORATED CARD BELOW TO JUGS SPORTS ↓

## Warranty Record

JUGS Serial No. \_\_\_\_\_ Date Delivered: \_\_\_\_\_

Model: \_\_\_\_\_

Name: \_\_\_\_\_

Address: \_\_\_\_\_

\_\_\_\_\_

\_\_\_\_\_ Zip: \_\_\_\_\_

Phone: ( ) \_\_\_\_\_

Purchased From: \_\_\_\_\_

Type of Activity (Youth League, High School, College, etc.): \_\_\_\_\_

Coach/Manager Name: \_\_\_\_\_



In the USA and Canada, call toll-free: 1-800-547-6843

Internationally, call collect: 0-503-692-1635

Fax us: 1-503-691-1100

Visit our website: [www.jugssports.com](http://www.jugssports.com)

---

Model

---

Serial No.

---

Date Delivered

↑ SAVE THIS PORTION FOR YOUR RECORDS ↑

---

---

---

---

PLACE  
STAMP  
HERE

**JUGS Sports**  
**P.O. Box 365**  
**Tualatin, Oregon 97062**



**If you need  
more information about  
this product  
or any other  
JUGS product or service,  
please contact  
the manufacturer:**



In the USA and Canada,  
call toll-free:  
1-800-547-6843.

For International Orders,  
call collect:  
0-503-692-1635.

Our fax number is  
1-503-691-1100.

Visit our website at  
[www.jugssports.com](http://www.jugssports.com).

Se habla español.